

ARTICLE 210

BRANCH CIRCUITS

Introduction to Article 210—Branch Circuits

This article contains the general requirements for branch circuits which extend from the last point of overcurrent protection to the utilization equipment. Branch circuits account for most circuits run in any electrical installation, so you must be sure you are familiar with these rules. Some topics covered in this material for Article 210 include:

- ▶ Identification of branch circuits
- ▶ Multi-wire branch circuits
- ▶ Voltage limitations
- ▶ Required branch circuits
- ▶ GFCI and AFCI requirements
- ▶ Branch-circuit ratings
- ▶ Permitted loads
- ▶ Receptacle and lighting outlet requirements

This article consists of three parts:

- ▶ Part I. General Provisions
- ▶ Part II. Branch-Circuit Ratings
- ▶ Part III. Required Outlets

Part III. Required Outlets

210.52 Dwelling Unit Receptacle Outlet Requirements

According to Article 100, “Receptacle Outlet” is where receptacles are installed. ▶[Figure 210-98](#)

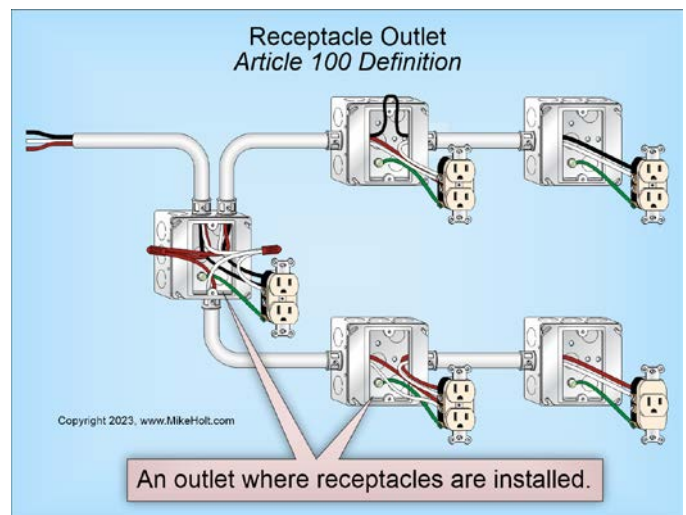

▶[Figure 210-98](#)

This section provides the requirements for 15A and 20A, 125V receptacle outlets in dwelling units. Receptacles or receptacle outlets located in the following locations do not count as the required 15A and 20A, 125V receptacle outlets under this section:

- (1) Receptacles that are part of a luminaire or appliance.
- (2) Receptacles controlled by a listed wall-mounted control device in accordance with 210.70(A)(1) Ex 1.
- (3) Receptacle outlets located within cabinets or cupboards.
- (4) Receptacle outlets located more than 5½ ft above the floor.

(A) General Requirements for Receptacle Outlets. A receptacle outlet must be installed in the walls for every kitchen, family room, dining room, living room, sunroom, parlor, library, den, bedroom, recreation room, and similar room or area in accordance with 210.52(1), (2), (3), and (4).

(1) Wall Space Receptacle Outlet Spacing. The wall space receptacle outlet must be installed so no point along the floor line of any wall is more than 6 ft, measured horizontally along the floor line, from a receptacle outlet. ▶Figure 210-99

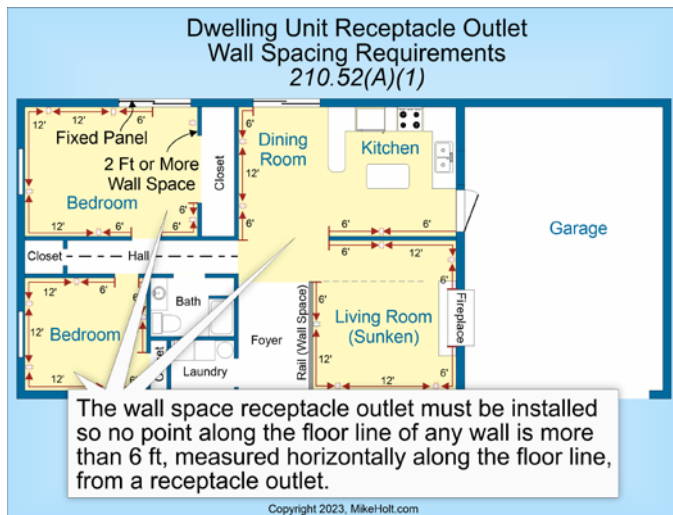

▶Figure 210-99

Author's Comment:

- ▶ The purpose of this rule is to ensure there are enough general-purpose receptacles conveniently located to reduce the chance an extension cord will be used.

(2) Wall Space Definition. The wall space for receptacle outlet placement includes the following:

- (1) Any wall space 2 ft or more in width that is unbroken along the floor line by doorways, fireplaces, stationary appliances, and fixed cabinets without countertops or work surfaces. ▶Figure 210-100 and ▶Figure 210-101

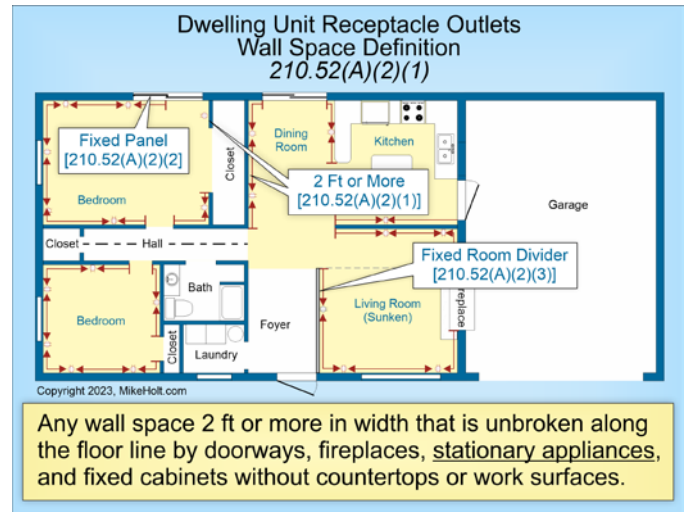

▶Figure 210-100



▶Figure 210-101

- (2) The space occupied by fixed panels.
- (3) The space occupied by fixed room dividers such as railings.

(3) Floor Receptacles. Floor receptacle outlets within 18 in. of the wall can be counted as the required wall space receptacle outlet.

▶Figure 210-102

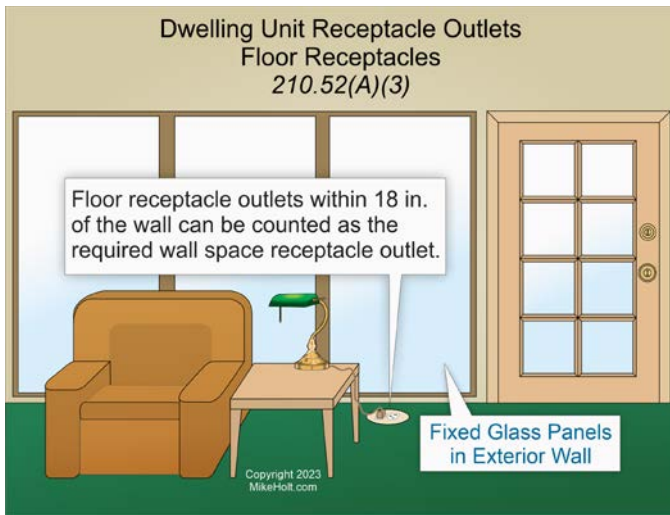

►Figure 210-102

Author's Comment:

- Spaces such as fixed panels in walls [210.52(A)(2)(2)] or fixed room dividers [210.52(A)(2)(3)] may be a railing or be constructed of glass, in which case installing a typical receptacle outlet is impractical. Since these fixed panels or room dividers are still considered a wall space, a floor receptacle within 18 in. can be used for the required receptacle(s).

(4) Countertop Receptacle Outlets. Receptacle outlets installed for countertop surfaces required by 210.52(C) cannot be used to meet the receptacle outlet rules for wall space outlined in 210.52(A).

(B) Small-Appliance Circuit Receptacle Outlets.

(1) Receptacle Outlets. In the kitchen, pantry, breakfast room, and dining room area of a dwelling unit, wall and floor receptacle outlets covered by 210.52(A), countertop outlets covered by 210.52(C), and receptacle outlets for refrigerators must be supplied by two or more 20A, 120V small-appliance branch circuits [210.11(C)(1)].

►Figure 210-103

Ex 2: An individual 15A or larger branch circuit can supply a receptacle outlet for a specific appliance such as a refrigerator in the kitchen, pantry, breakfast room, and dining room area of a dwelling unit.

►Figure 210-104

(2) Not to Supply Other Outlets. The 20A, 120V small-appliance circuits required by 210.11(C)(1) are not permitted to supply lighting outlets or receptacle outlets outside the kitchen, pantry, breakfast room, or dining room area. ►Figure 210-105

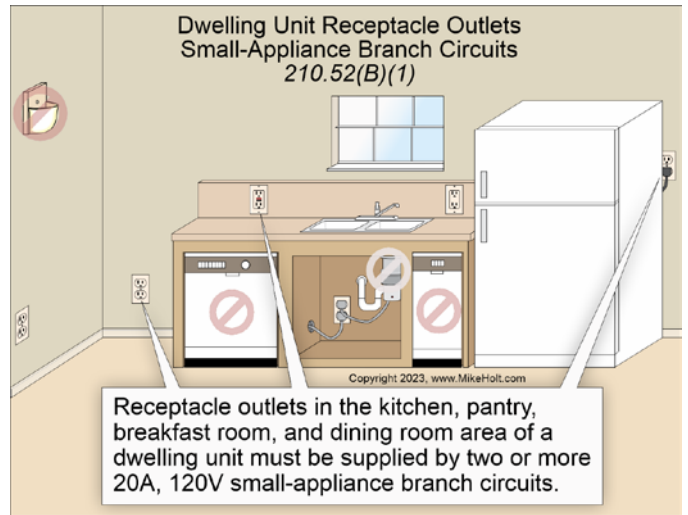

►Figure 210-103

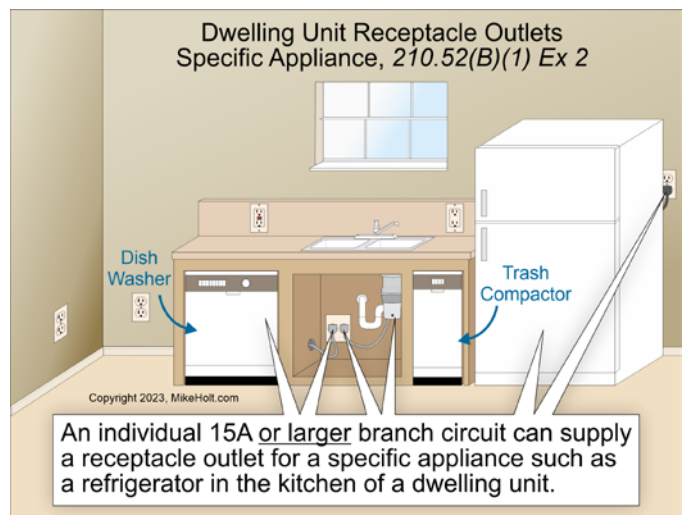

►Figure 210-104

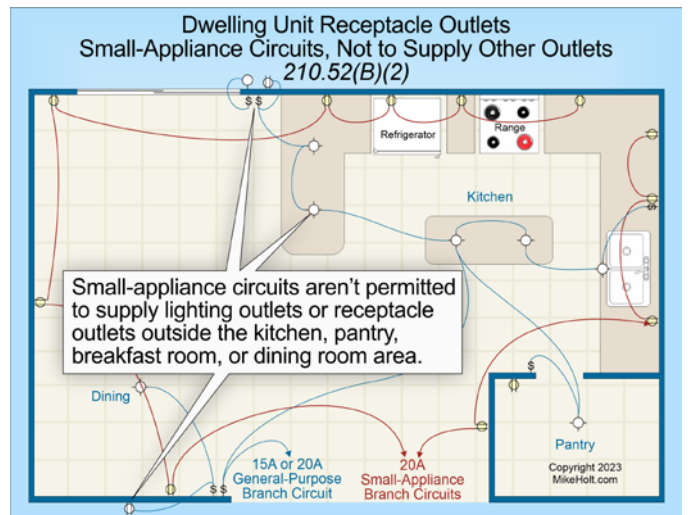

►Figure 210-105

Ex 2: A receptacle outlet for a gas-fired range, oven, or counter-mounted cooking unit is permitted on the 20A, 120V small-appliance circuit.

►Figure 210-106

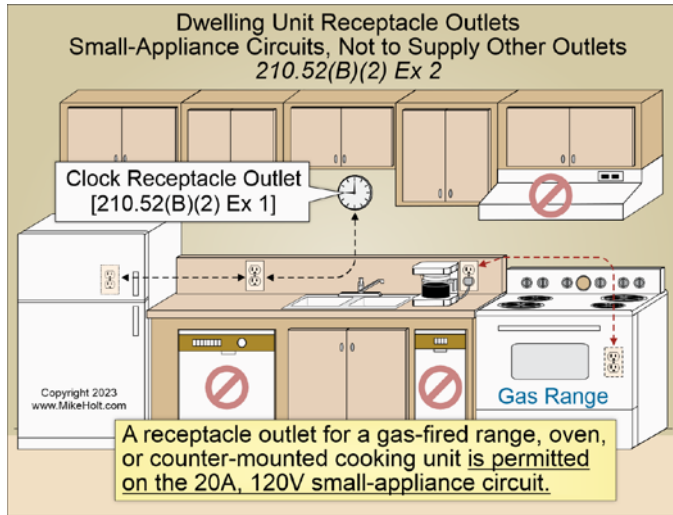

►Figure 210-106

Author's Comment:

- A range hood (or over-the-range microwave listed as a range hood that is flexible cord-and-plug-connected) must be supplied by an individual branch circuit [422.16(B)(4)(3)]. A hardwired range hood is not permitted to be supplied by the small-appliance branch circuit(s).

(3) Kitchen Receptacle Requirements. Receptacles installed in a kitchen to serve countertop surfaces must be supplied by no fewer than two small-appliance branch circuits, either or both of which can supply receptacle outlets in the same kitchen, pantry, breakfast room, or dining room area as specified in 210.52(B)(1). ►Figure 210-107

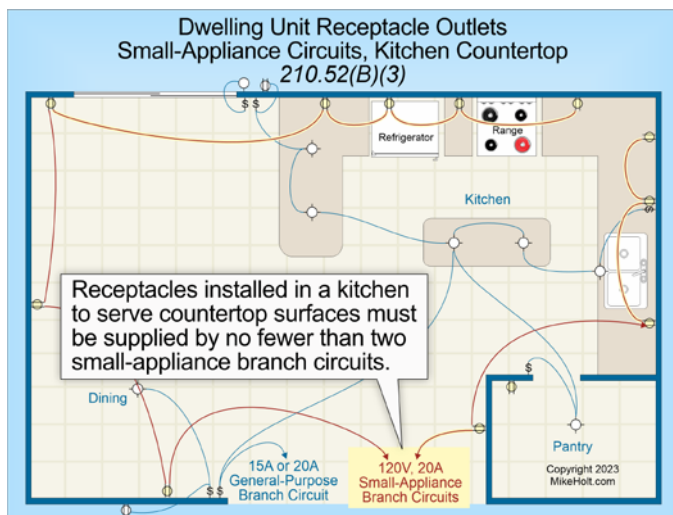

►Figure 210-107

(C) Countertop Requirements. In kitchens, pantries, breakfast rooms, dining rooms, and similar areas of dwelling units, receptacle outlets for countertop and work surfaces 12 in. or wider must be installed in accordance with 210.52(C)(1) through (C)(3) and not permitted to be used to meet the receptacle outlets for wall space required by 210.52(A).

Two or more receptacles in each 1-ft section of an multioutlet assembly, are considered a single receptacle outlet.

(1) Countertop Wall Spaces. A receptacle outlet must be installed so no point along the countertop wall space is more than 2 ft, measured horizontally, from a receptacle outlet. ►Figure 210-108

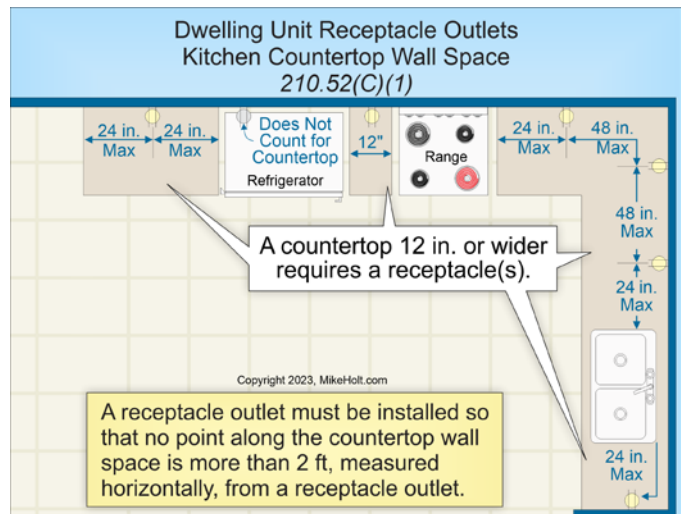

►Figure 210-108

According to Article 100, “Countertop” is a surface intended for food preparation and serving, or a surface that presents a routine risk of spillage of large quantities of water. ►Figure 210-109

Ex 1: A receptacle outlet is not required directly behind a range, counter-mounted cooking unit, or sink in accordance with Figure 210.52(C)(1) in the NEC. ►Figure 210-110

Author's Comment:

- If the countertop space behind a range or sink is larger than the dimensions noted in Figure 210.52(C)(1) of the Code book, then a GFCI-protected receptacle must be installed in that space. This is because (for all practical purposes) if there is enough space for an appliance, it is assumed one will be placed there.



►Figure 210-109

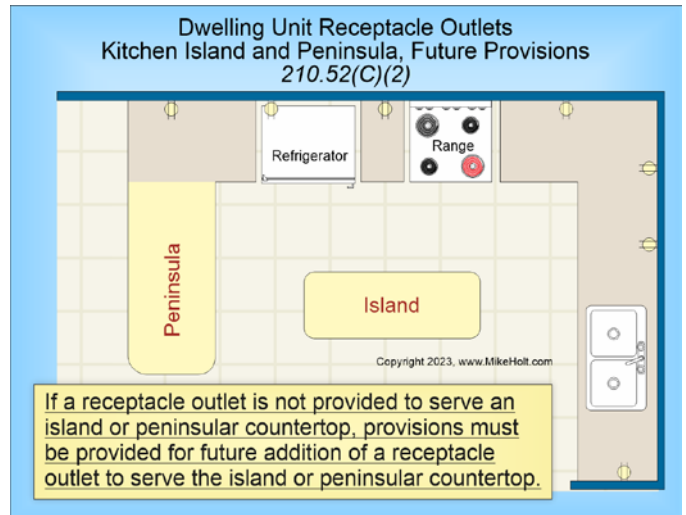

►Figure 210-111

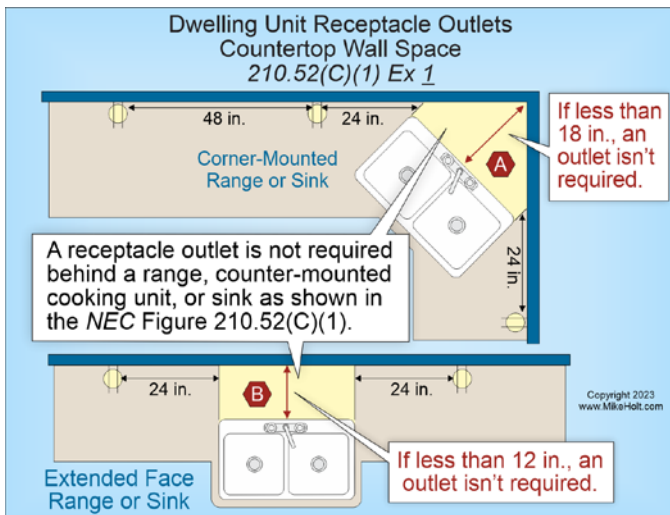

►Figure 210-110

Ex 2: Where a required receptacle outlet cannot be installed in the wall areas shown in Figure 210.52(C)(1) of the NEC, the required receptacle outlet is permitted to be installed as close as practicable to the countertop area to be served. The total number of receptacle outlets serving the countertop must not be less than the number needed to satisfy 210.52(C)(1). These outlets must be in accordance with 210.52(C)(3).

(2) Island and Peninsular Countertops. If a receptacle outlet is not provided to serve an island or peninsular countertop, provisions must be provided at the island or peninsula for the future addition of a receptacle outlet to serve the island or peninsular countertop.

►Figure 210-111

(3) Countertop Receptacle Location. The required receptacle outlets must be installed in one or more of the following locations:

(1) On or Above Countertops. The required receptacle outlets can be installed on or not more than 20 in. above the countertop. ►Figure 210-112

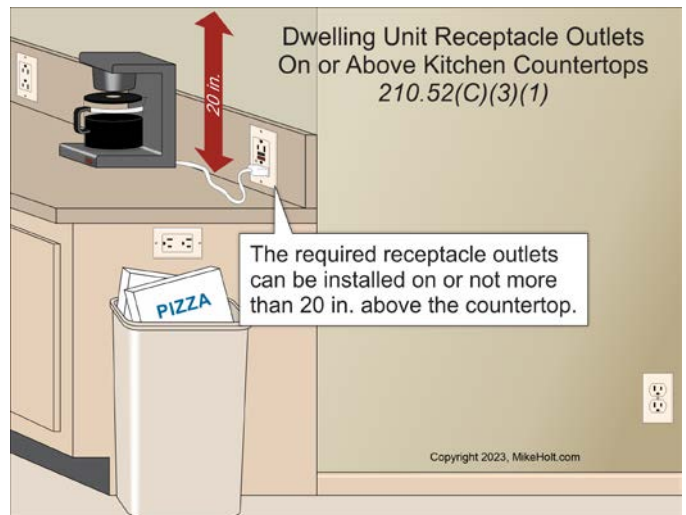

►Figure 210-112

Author's Comment:

- Receptacle outlets installed at islands and peninsulas must be located on or above the countertop or work surface. ►Figure 210-113

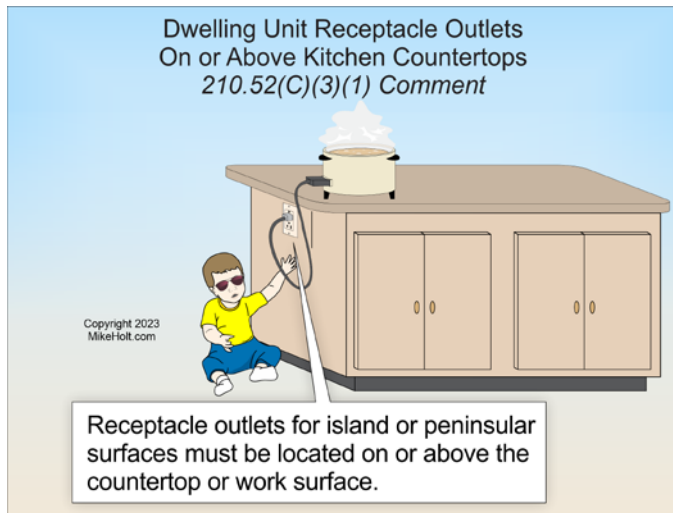

▶Figure 210-113

(2) In Countertops. The required receptacle outlets can be in the countertop with receptacle outlet assemblies listed for use in countertops. ▶Figure 210-114



▶Figure 210-114

Receptacle outlets rendered not readily accessible by appliances fastened in place in an appliance garage, behind sinks, ranges, or cooktops [210.52(C)(1) Ex 1], or supplying appliances that occupy assigned spaces, do not count as the required countertop surface receptacle outlets.

Author's Comment:

- ▶ An "Appliance Garage" is an enclosed area on the countertop where an appliance can be stored and hidden from view when not in use. Receptacles installed inside an appliance garage do not count as a required countertop receptacle outlet.

Note 1: For the installation of receptacles in countertops, see 406.5(E). For installation of receptacles in work surfaces, see 406.5(F), and for the installation of multioutlet assemblies in work surfaces, see 380.10.

(D) Bathroom Sink Receptacle Outlet(s). At least one 15A or 20A, 125V receptacle outlet must be installed within 3 ft of the outside edge of each bathroom sink.

The receptacle outlet must be on a wall or partition adjacent to the sink counter surface or on the side or face of the sink cabinet. In no case can the receptacle outlet be more than 12 in. below the top of the sink or sink countertop. ▶Figure 210-115

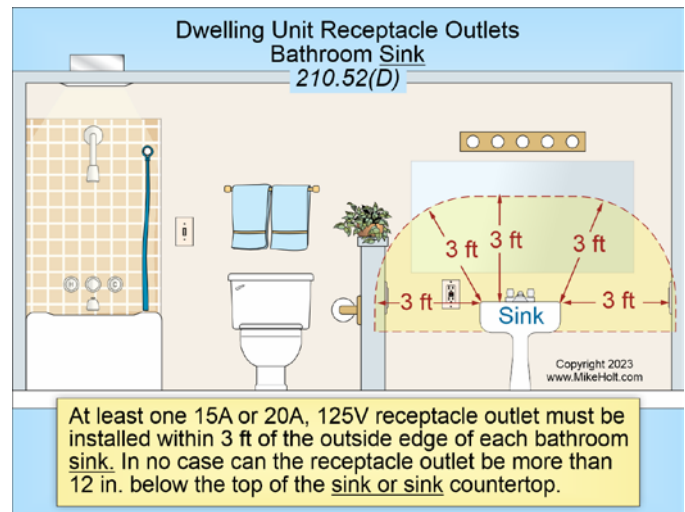

▶Figure 210-115

Author's Comment:

- ▶ One bathroom receptacle outlet can serve two sinks to meet this requirement if it is within 3 ft of the outside edge of each sink. ▶Figure 210-116

Receptacle outlet assemblies listed for use in countertops are permitted to be installed in the bathroom sink countertop surface.

Note 1: For the installation of receptacles in countertops, see 406.5(E) and 406.5(G).

(E) Outdoor Receptacle Outlets. Outdoor receptacle outlets must comply with the following:

(1) One- and Two-Family Dwellings. One outdoor receptacle outlet must be installed at the front and back of each dwelling unit (two receptacles in total). They must be readily accessible from grade and cannot be more than 6½ ft above grade. ▶Figure 210-117

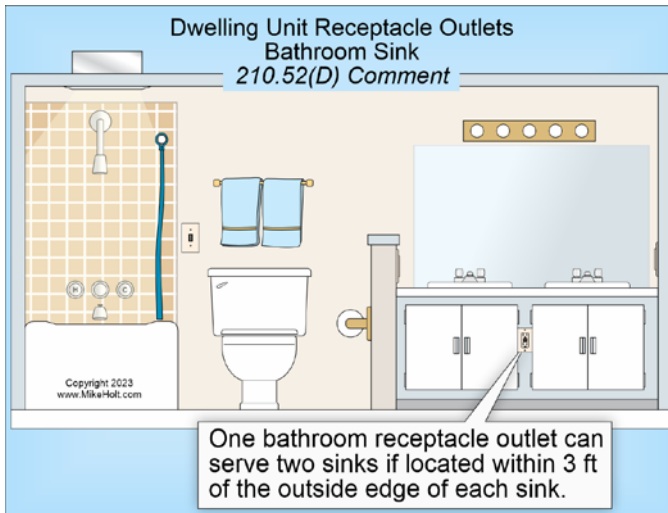

▶Figure 210-116

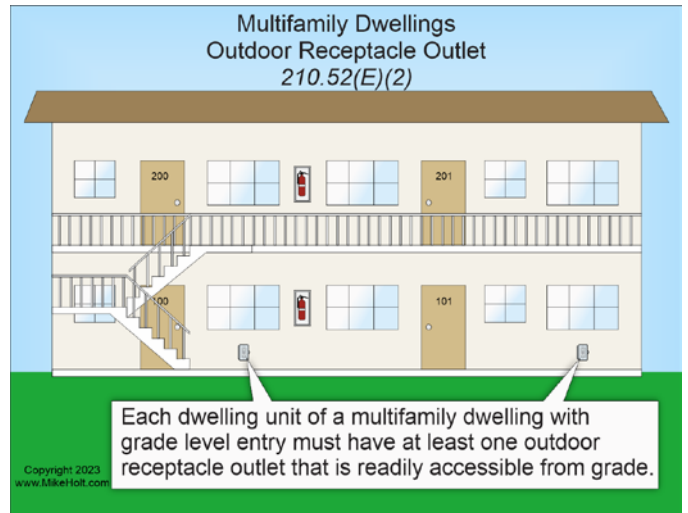

▶Figure 210-118

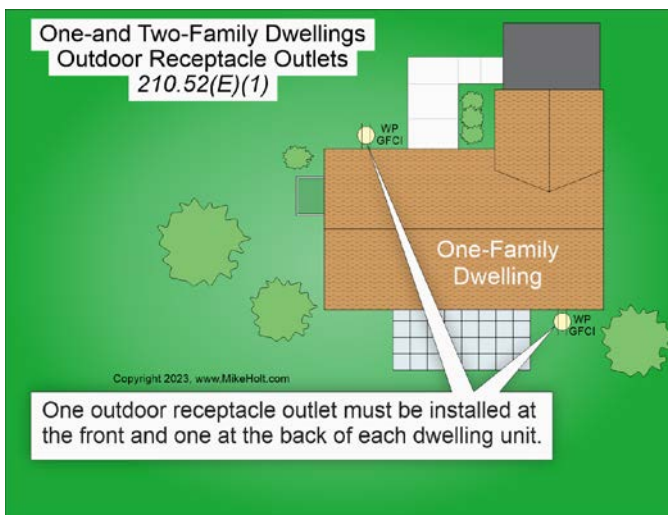

▶Figure 210-117

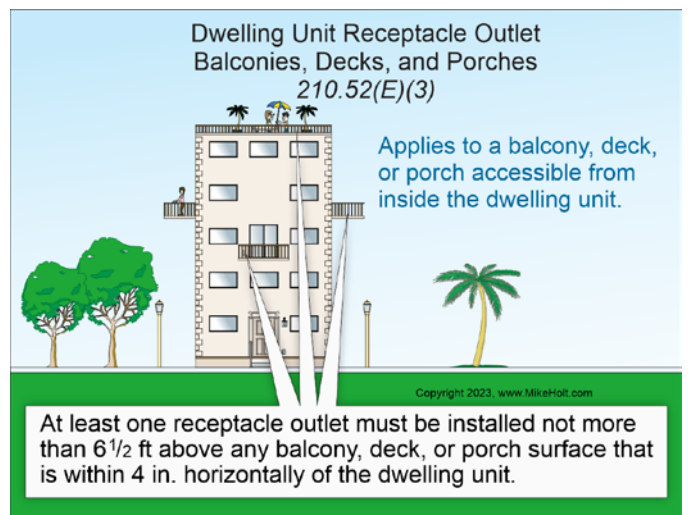

▶Figure 210-119

(2) Multifamily Dwelling. Each dwelling unit of a multifamily dwelling with grade-level entry must have at least one outdoor receptacle outlet, readily accessible from grade, and not more than 6½ ft above grade. ▶Figure 210-118

(3) Balconies, Decks, and Porches. At least one receptacle outlet must be installed not more than 6½ ft above any balcony, deck, or porch surface within 4 in. horizontally of the dwelling unit. ▶Figure 210-119

(F) Laundry Area Receptacle Outlet(s). Each dwelling unit must have one receptacle outlet installed in the area where laundry equipment is intended to be installed. ▶Figure 210-120

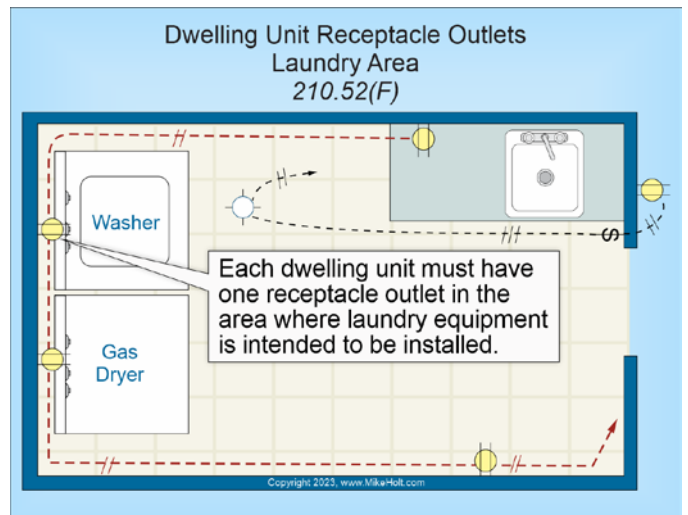

▶Figure 210-120

Ex 1: A laundry receptacle outlet is not required in a dwelling unit located in a multifamily dwelling building with laundry facilities available to all occupants.

According to Article 100, “Laundry Area” is designed to contain a laundry tray, washing machine, or clothes dryer regardless of whether laundry equipment is installed.

(G) Garage, Basement, and Accessory Building Receptacle Outlet(s). For one- and two-family dwellings or multifamily dwellings, at least one receptacle outlet must be installed in accordance with 210.52G(1) through (3). Receptacles supplying only a permanently installed premises security system are not considered as meeting these requirements.

(1) Garages. A receptacle outlet is required in each vehicle bay of a garage with electric power and installed no higher than 5 ft 6 in. above the floor. ▶[Figure 210-121](#)

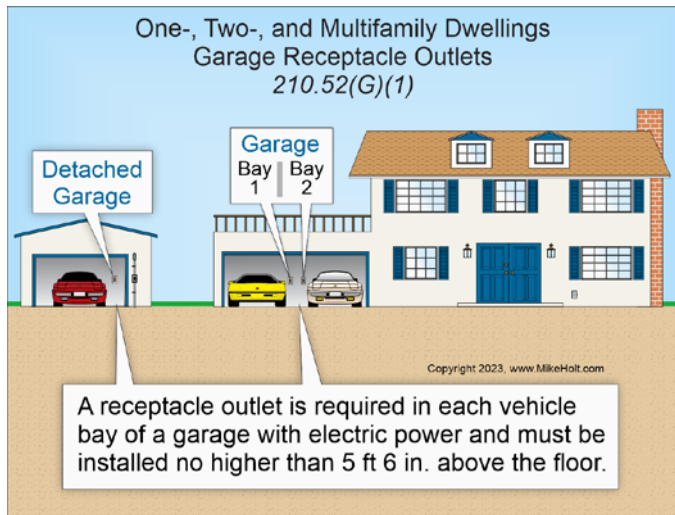

▶[Figure 210-121](#)

Ex: A receptacle outlet is not required in a garage space not attached to an individual dwelling unit of a multifamily dwelling.

(2) Accessory Building Receptacle Outlets. A receptacle outlet is required in each accessory building with electric power. ▶[Figure 210-122](#)

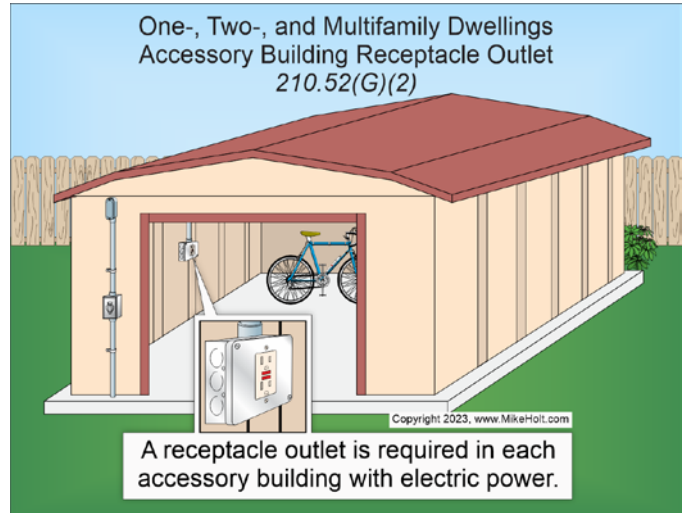

▶[Figure 210-122](#)

(3) Basements. Each unfinished portion of a basement must have a receptacle outlet. ▶[Figure 210-123](#)

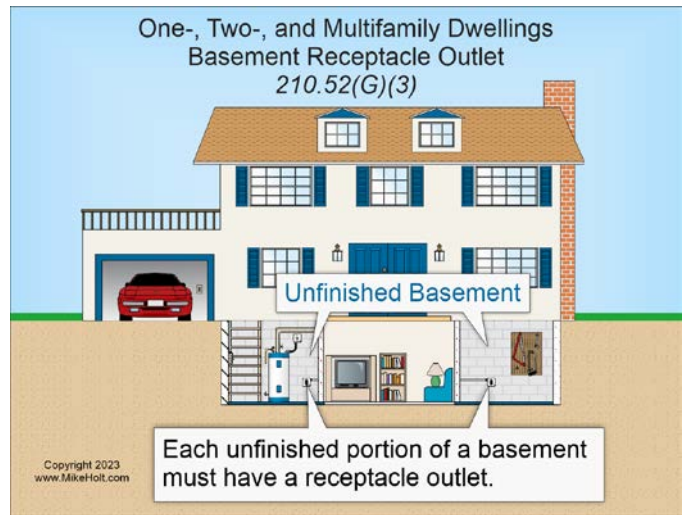

▶[Figure 210-123](#)

(H) Hallway Receptacle Outlet. At least one receptacle outlet must be installed in each hallway 10 ft or more in length, measured along the centerline of the hallway without passing through a doorway.

▶Figure 210-124

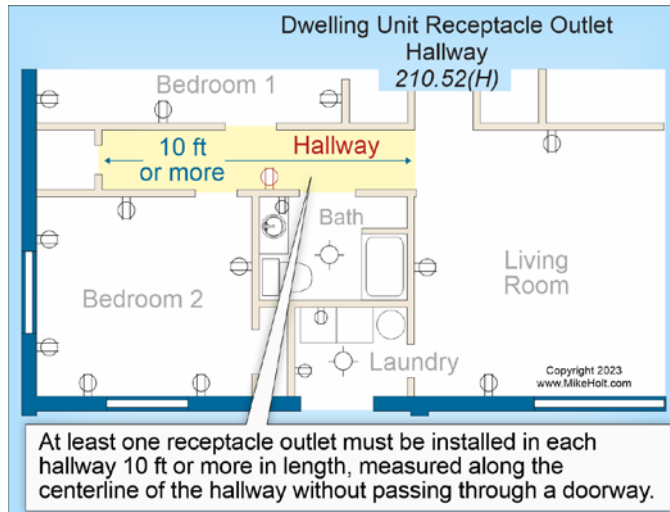

▶Figure 210-124

(I) Foyer Receptacle Outlet(s). Foyers having an area greater than 60 sq ft must have a receptacle outlet on any wall space that is 3 ft or more in width and unbroken by doorways, windows next to doors that extend to the floor, and similar openings. ▶Figure 210-125

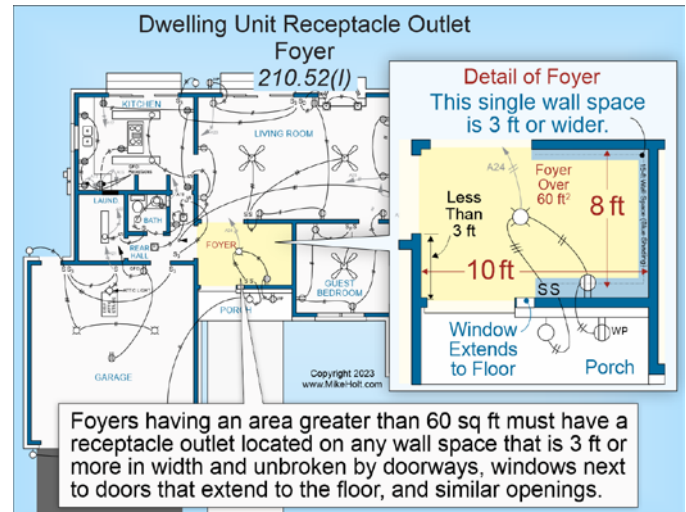

▶Figure 210-125