

Mike Holt's Illustrated Guide to

THE TOP 10 RULES OF THE 2014 NATIONAL ELECTRICAL CODE®

Based on the 2014 NEC®

Rules 110.14, 110.16, 210.8, 210.12, 240.21, 250.24, 250.122, 404.2, 406.12, 680.26

Extracted from Mike Holt's Illustrated Guide to Understanding
the National Electrical Code® • Volumes 1 and 2

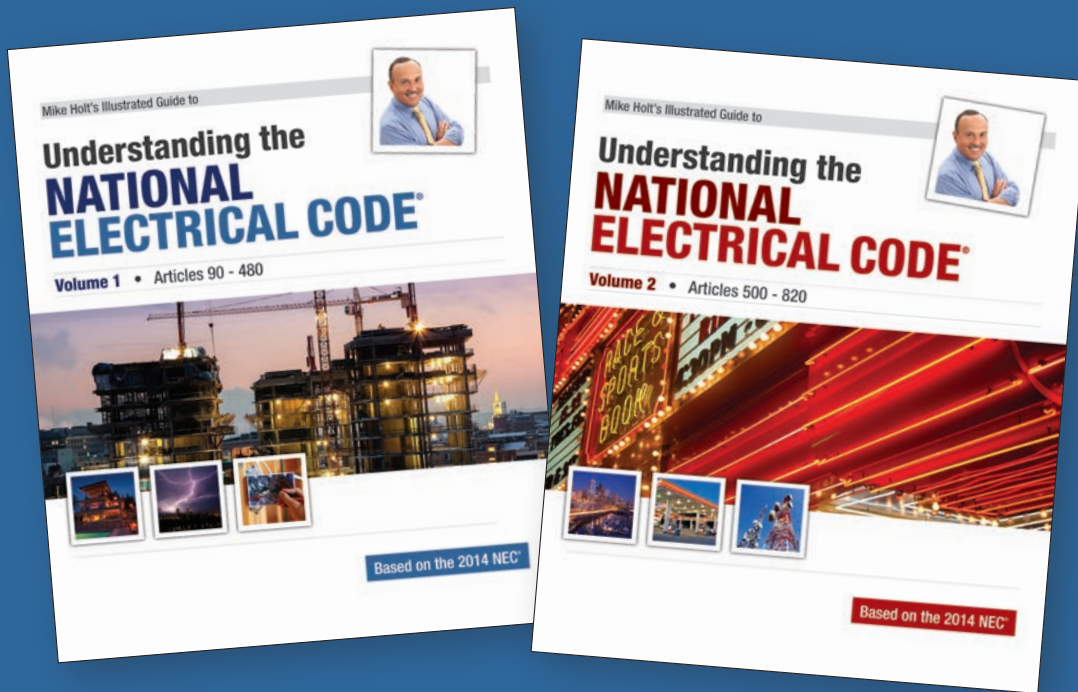

For more information on this or other training products,
visit www.MikeHolt.com or call 888.632.2633



Mike Holt Enterprises, Inc.

888.NEC.CODE (632.2633) • www.MikeHolt.com

Date: June 21, 2016

NOTICE TO THE READER

The publisher does not warrant or guarantee any of the products described herein or perform any independent analysis in connection with any of the product information contained herein. The publisher does not assume, and expressly disclaims, any obligation to obtain and include information other than that provided to it by the manufacturer.

The reader is expressly warned to consider and adopt all safety precautions that might be indicated by the activities herein and to avoid all potential hazards. By following the instructions contained herein, the reader willingly assumes all risks in connection with such instructions.

The publisher makes no representation or warranties of any kind, including but not limited to, the warranties of fitness for particular purpose or merchantability, nor are any such representations implied with respect to the material set forth herein, and the publisher takes no responsibility with respect to such material. The publisher shall not be liable for any special, consequential, or exemplary damages resulting, in whole or part, from the reader's use of, or reliance upon, this material.

Author: Mike Holt

Technical Illustrator: Mike Culbreath

COPYRIGHT © 2015 Charles Michael Holt



Produced and Printed in the USA

All rights reserved. No part of this work covered by the copyright hereon may be reproduced or used in any form or by any means graphic, electronic, or mechanical, including photocopying, recording, taping, or information storage and retrieval systems without the written permission of the publisher. You can request permission to use material from this text by either calling 888.632.2633, e-mailing Info@MikeHolt.com, or visiting www.MikeHolt.com.

For more information, call 888.NEC.CODE (632.2633), or e-mail Info@MikeHolt.com.

NEC[®], NFPA 70[®], NFPA 70E[®] and National Electrical Code[®] are registered trademarks of the National Fire Protection Association.



This logo is a registered trademark of Mike Holt Enterprises, Inc.

ABOUT THE AUTHOR

Mike Holt worked his way up through the electrical trade. He began as an apprentice electrician and became one of the most recognized experts in the world as it relates to electrical power installations. He's worked as a journeyman electrician, master electrician, and electrical contractor. Mike's experience in the real world gives him a unique understanding of how the *NEC* relates to electrical installations from a practical standpoint.



You'll find his writing style to be direct, nontechnical, and powerful.

Did you know Mike didn't finish high school? So if you struggled in high school or didn't finish at all, don't let it get you down. However, realizing that success depends on one's continuing pursuit of education, Mike immediately attained his GED, and ultimately attended the University of Miami's Graduate School for a Master's degree in Business Administration.

Mike resides in Central Florida, is the father of seven children, has five grandchildren, and enjoys many outside interests and activities. He's a nine-time National Barefoot Water-Ski Champion (1988, 1999, 2005–2009, 2012–2013). He's set many national records and continues to train year-round at a World competition level (www.barefootwaterskier.com).

What sets him apart from some is his commitment to living a balanced lifestyle; placing God first, family, career, then self.

*I dedicate this book to the
Lord Jesus Christ,
my mentor and teacher.
Proverbs 16:3*





TABLE OF CONTENTS

Article 110—Requirements for Electrical Installations

Rule 1 110.14 Conductor Termination and Splicing 4

Rule 2 110.16 Arc-Flash Hazard Warning..... 9

Article 210—Branch Circuits

Rule 3 210.8 GFCI Protection 11

Rule 4 210.12 Arc-Fault Circuit-Interrupter Protection..... 18

Article 240—Overcurrent Protection

Rule 5 240.21 Overcurrent Protection Location in Circuit..... 22

Article 250—Grounding and Bonding

Rule 6 250.24 Service Equipment-Grounding and Bonding 27

Rule 7 250.122 Sizing Equipment Grounding Conductor 33

Article 404—Switches

Rule 8 404.2 Switch Connections 36

Article 406—Receptacles, Cord Connectors, and Attachment Plugs (Caps)

Rule 9 406.12 Tamper-Resistant Receptacles 39

Article 680—Swimming Pools, Spas, Hot Tubs, Fountains, and Similar Installations

Rule 10 680.26 Equipotential Bonding 41

ARTICLE 110

REQUIREMENTS FOR ELECTRICAL INSTALLATIONS

Introduction to Article 110—Requirements for Electrical Installations

Article 110 sets the stage for how you'll implement the rest of the *NEC*. This article contains a few of the most important and yet neglected parts of the *Code*. For example:

- How should conductors be terminated?
- What kinds of warnings, markings, and identification does a given installation require?
- What's the right working clearance for a given installation?
- What do the temperature limitations at terminals mean?
- What are the *NEC* requirements for dealing with flash protection?

It's critical that you master Article 110, and that's exactly what this *Illustrated Guide to Understanding the National Electrical Code* is designed for. As you read this article, you're building your foundation for correctly applying the *NEC*. In fact, this article itself is a foundation for much of the *Code*. The purpose for the *National Electrical Code* is to provide a safe installation, but Article 110 is perhaps focused a little more on providing an installation that's safe for the installer and maintenance electrician, so time spent in this article is time well spent.

Part I. General Requirements

Rule #1:

110.14 Conductor Termination and Splicing

Conductor terminal and splicing devices must be identified for the conductor material and they must be properly installed and used. [Figure 110-21](#)

Author's Comment:

- Switches and receptacles marked CO/ALR are designed to ensure a good connection through the use of a larger contact area and compatible materials. The terminal screws are plated with the element called "Indium." Indium is an extremely soft metal that forms a gas-sealed connection with the aluminum conductor.

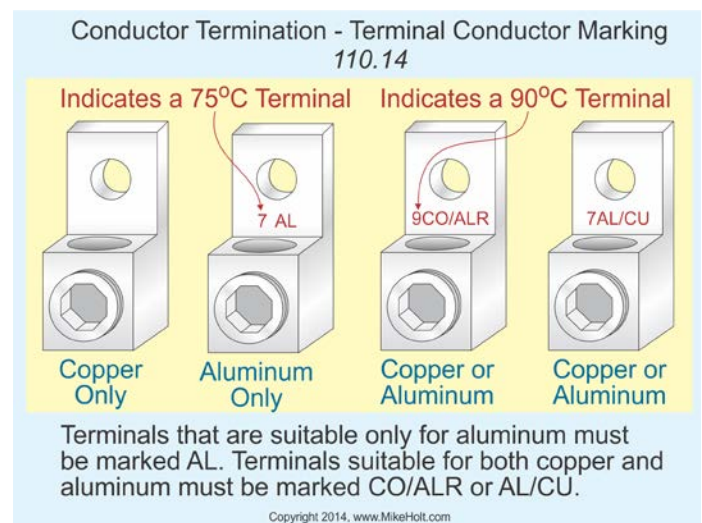

Figure 110-21

Connectors and terminals for conductors more finely stranded than Class B and Class C, as shown in Table 10 of Chapter 9, must be identified for the use of finely stranded conductors. [Figure 110-22](#)



Figure 110-22

Author's Comment:

- According to UL Standard 486 A-B, a terminal/lug/connector must be listed and marked for use with other than Class B stranded conductors. With no marking or factory literature/instructions to the contrary, terminals may only be used with Class B stranded conductors.
- See the definition of "Identified" in Article 100.
- Conductor terminations must comply with the manufacturer's instructions as required by 110.3(B). For example, if the instructions for the device state "Suitable for 18-12 AWG Stranded," then only stranded conductors can be used with the terminating device. If the instructions state "Suitable for 18-12 AWG Solid," then only solid conductors are permitted, and if the instructions state "Suitable for 18-12 AWG," then either solid or stranded conductors can be used with the terminating device.

Copper and Aluminum Mixed. Copper and aluminum conductors must not make contact with each other in a device unless the device is listed and identified for this purpose.

Author's Comment:

- Few terminations are listed for the mixing of aluminum and copper conductors, but if they are, that'll be marked on the product package or terminal device. The reason copper and aluminum shouldn't be in contact with each other is because corrosion develops between the two different metals due to galvanic action, resulting in increased contact resistance at the splicing device. This increased resistance can cause the splice to overheat and cause a fire.

Note: Many terminations and equipment are either marked with a tightening torque or have the torque values included in the product's instructions. [Figure 110-23](#)

Conductor Termination
Manufacturer's Torque Specifications
 110.14 Note

BRANCH AND NEUTRAL	
WIRE RANGE	TORQUE IN.-LBS
14-10 CU, 12-10 AL	20
8 CU-AL	25
6-4 CU-AL	35

EQUIP. GND. BAR COMBINATIONS	
TWO 14 OR 12 CU	25
TWO 12 OR 10 AL	

Many terminations and equipment are either marked with a tightening torque or have the torque values included in the installation instructions.

Copyright 2014, www.MikeHolt.com

Figure 110-23

Author's Comment:

- Conductors must terminate in devices that have been properly tightened in accordance with the manufacturer's torque specifications included with equipment instructions. Failure to torque terminals can result in excessive heating of terminals or splicing devices due to a loose connection. A loose connection can also lead to arcing which increases the heating effect and may also lead to a short circuit or ground fault. Any of these can result in a fire or other failure, including an arc-flash event. In addition, this is a violation of 110.3(B), which requires all equipment to be installed in accordance with listing or labeling instructions.

Question: What do you do if the torque value isn't provided with the device?

Answer: In the absence of connector or equipment manufacturer's recommended torque values, Table I.1, Table I.2, and Table I.3 contained in Annex I may be used to correctly tighten screw-type connections for power and lighting circuits.

Author's Comment:

- Terminating conductors without a torque tool can result in an improper and unsafe installation. If a torque screwdriver isn't used, there's a good chance the conductors aren't properly terminated.

(A) Terminations. Conductor terminals must ensure a good connection without damaging the conductors and must be made by pressure connectors (including set screw type) or splices to flexible leads. [Figure 110-24](#)



Figure 110-24

Author's Comment:

- See the definition of "Connector, Pressure" in Article 100.

Question: What if the conductor is larger than the terminal device?

Answer: This condition needs to be anticipated in advance, and the equipment should be ordered with terminals that'll accommodate the larger conductor. However, if you're in the field, you should:

- Contact the manufacturer and have them express deliver you the proper terminals, bolts, washers, and nuts, or
- Order a terminal device that crimps on the end of the larger conductor and reduces the termination size.

Terminals for more than one conductor and terminals used for aluminum conductors must be identified for this purpose, either within the equipment instructions or on the terminal itself. [Figure 110-25](#)

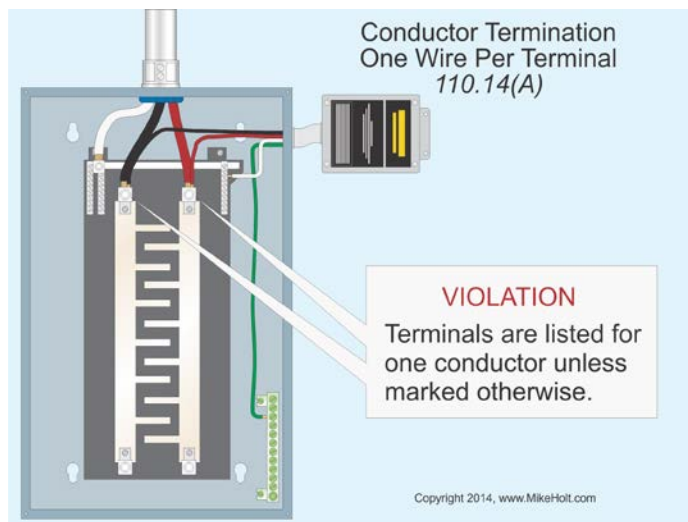

Figure 110-25

Author's Comment:

- Split-bolt connectors are commonly listed for only two conductors, although some are listed for three conductors. However, it's a common industry practice to terminate as many conductors as possible within a split-bolt connector, even though this violates the *NEC*. [Figure 110-26](#)

(B) Conductor Splices. Conductors must be spliced by a splicing device identified for the purpose or by exothermic welding.

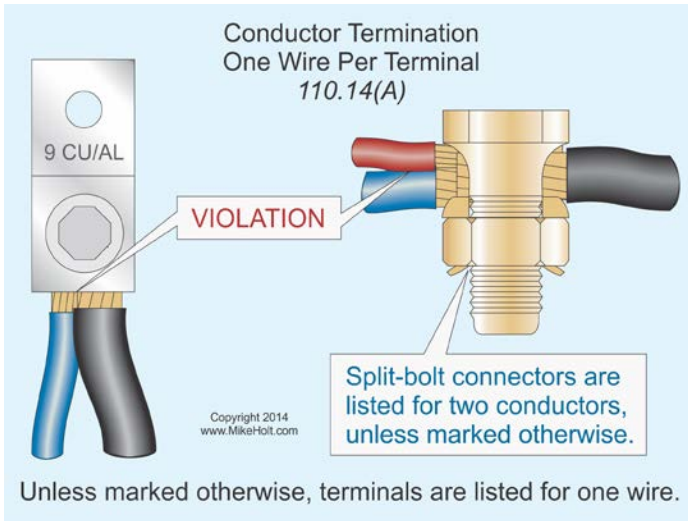

Figure 110-26

Author's Comment:

- Conductors aren't required to be twisted together prior to the installation of a twist-on wire connector, unless specifically required in the installation instructions. [Figure 110-27](#)

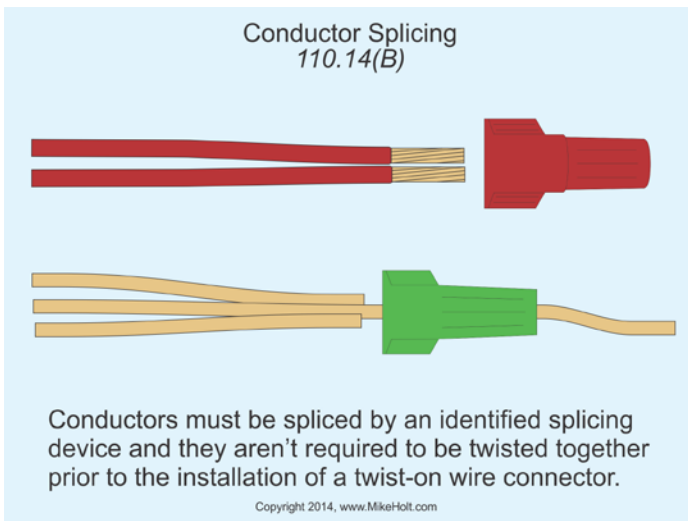

Figure 110-27

Unused circuit conductors aren't required to be removed. However, to prevent an electrical hazard, the free ends of the conductors must be insulated to prevent the exposed end of the conductor from touching energized parts. This requirement can be met by the use of an insulated twist-on or push-on wire connector. [Figure 110-28](#)

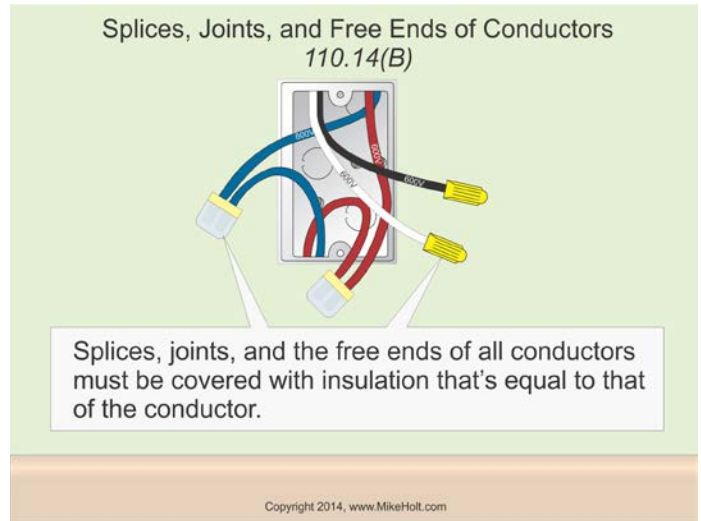

Figure 110-28

Author's Comment:

- See the definition of "Energized" in Article 100.

Underground Splices:

Single Conductors. Single direct burial conductors of types UF or USE can be spliced underground without a junction box, but the conductors must be spliced with a device listed for direct burial [300.5(E) and 300.15(G)]. [Figure 110-29](#)

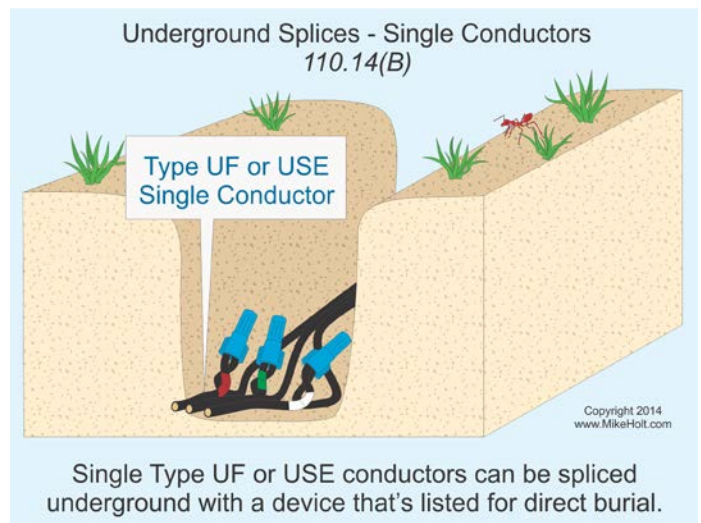

Figure 110-29

Multiconductor Cable. Multiconductor UF or USE cable can have the individual conductors spliced underground without a junction box as long as a listed splice kit that encapsulates the conductors as well as the cable jacket is used.

(C) Temperature Limitations (Conductor Size). Conductors are to be sized using their ampacity from the insulation temperature rating column of Table 310.15(B)(16) that corresponds to the lowest temperature rating of any terminal, device, or conductor of the circuit.

Author's Comment:

- Conductors with insulation temperature ratings higher than the termination's temperature rating can be used for ampacity adjustment, correction, or both. [Figure 110–30](#)

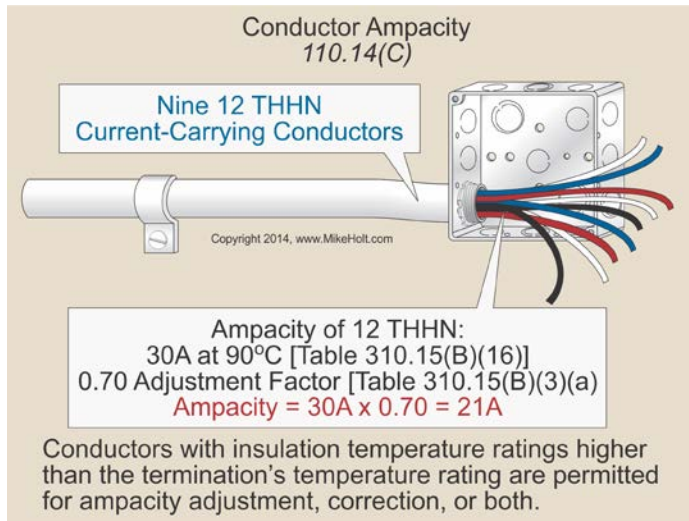

Figure 110–30

(1) Equipment Temperature Rating Provisions. Unless the equipment is listed and marked otherwise, conductor sizing for equipment terminations must be based on Table 310.15(B)(16) in accordance with (a) or (b):

(a) Equipment Rated 100A or Less.

- (1) Conductors must be sized using the 60°C temperature column of Table 310.15(B)(16). [Figure 110–31](#)
- (3) Conductors terminating on terminals rated 75°C are sized in accordance with the ampacities listed in the 75°C temperature column of Table 310.15(B)(16). [Figure 110–32](#)

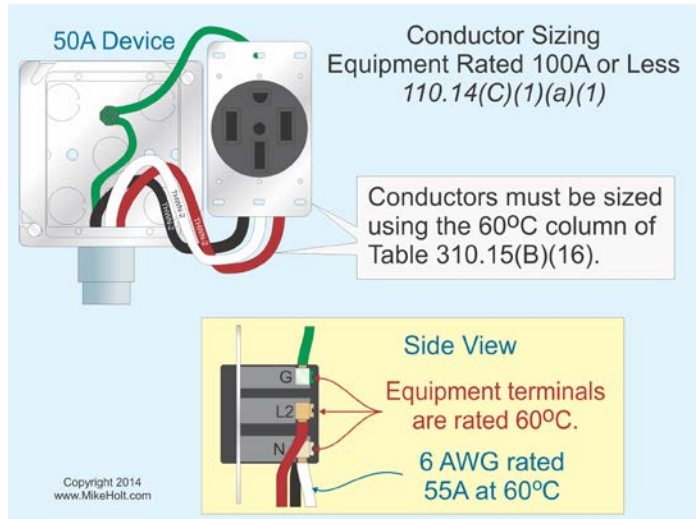

Figure 110–31

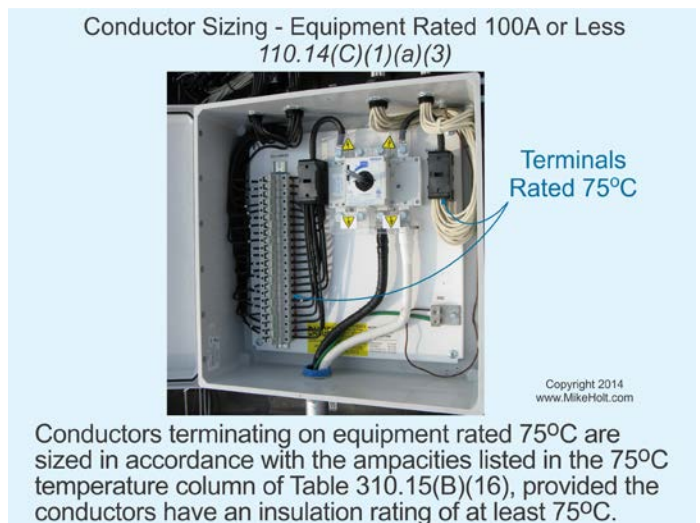

Figure 110–32

- (4) Motors marked with design letters B, C, or D, conductors having an insulation rating of 75°C or higher can be used, provided the ampacity of such conductors doesn't exceed the 75°C ampacity. [Figure 110–33](#)

(b) Equipment Rated Over 100A.

- (1) Conductors must be sized using the 75°C temperature column of Table 310.15(B)(16). [Figure 110–34](#)
- (2) Separate Connector Provisions.** Conductors can be sized to the 90°C column of Table 310.15(B)(16) if the conductors and pressure connectors are rated at least 90°C. [Figure 110–35](#)

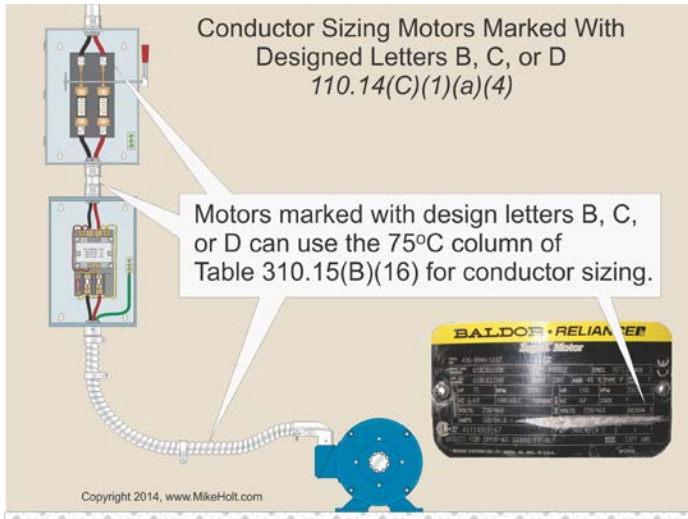

Figure 110-33

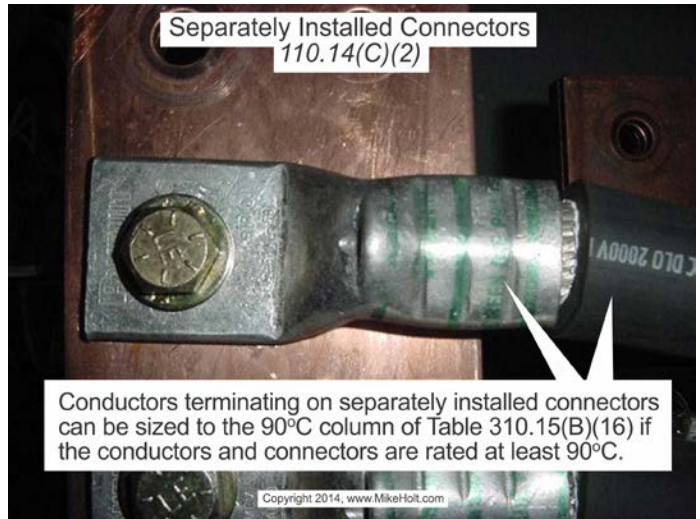

Figure 110-35

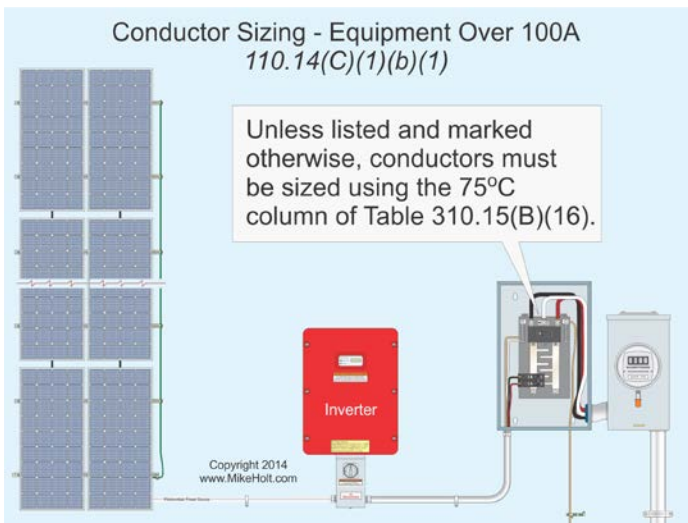

Figure 110-34

Note: Equipment markings or listing information may restrict the sizing and temperature ratings of connected conductors.

Rule #2: 110.16 Arc-Flash Hazard Warning

Electrical equipment such as switchboards, switchgear, panelboards, industrial control panels, meter socket enclosures, and motor control centers in other than dwelling units that are likely to require examination, adjustment, servicing, or maintenance while energized must be

marked to warn qualified persons of the danger associated with an arc flash from short circuits or ground faults. The marking can be made in the field or the factory, must not be handwritten, must be permanently affixed, be of sufficient durability to withstand the environment involved [110.21(B)], and be clearly visible to qualified persons before they examine, adjust, service, or perform maintenance on the equipment. Figure 110-38

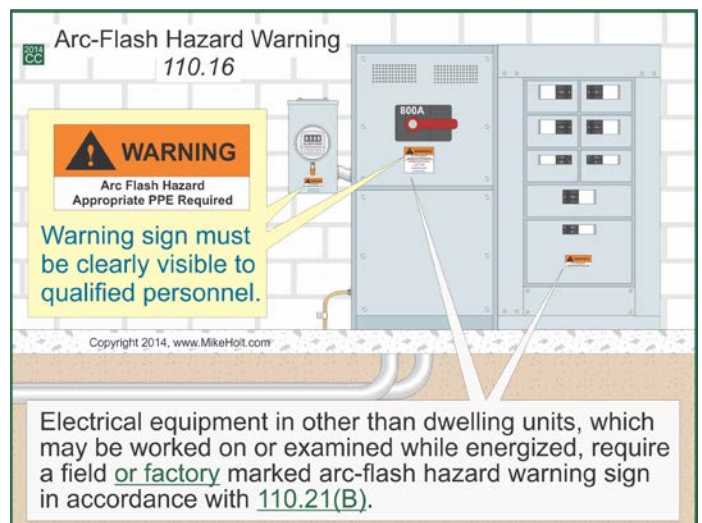

Figure 110-38

Author's Comment:

- See the definition of “Qualified Person” in Article 100.
- This rule is meant to warn qualified persons who work on energized electrical systems that an arc flash hazard exists so they’ll select proper personal protective equipment (PPE) in accordance with industry accepted safe work practice standards.

Note 1: NFPA 70E, *Standard for Electrical Safety in the Workplace*, provides assistance in determining the severity of potential exposure, planning safe work practices, [arc-flash labeling](#), and selecting personal protective equipment.

ARTICLE 210

BRANCH CIRCUITS

Introduction to Article 210—Branch Circuits

This article contains the requirements for branch circuits, such as conductor sizing and identification, GFCI protection, and receptacle and lighting outlet requirements. It consists of three parts:

- **Part I. General Provisions**
- **Part II. Branch-Circuit Ratings**
- **Part III. Required Outlets**

Table 210.2 of this article identifies specific-purpose branch circuits. The provisions for branch circuits that supply equipment listed in Table 210.2 amend or supplement the provisions given in Article 210 for branch circuits, so it's important to be aware of the contents of this table.

The following sections are part of the Top 10 Rules of 2014:

- **210.8—GFCI Protection.** Crawl spaces, unfinished basements, and boathouses are just some of the many locations that require GFCI protection.
- **210.12—Arc-Fault Circuit-Interrupter Protection.** An arc-fault circuit interrupter (AFCI) is a device intended to de-energize a circuit when it detects the current waveform characteristics unique to an arcing fault. The purpose of an AFCI is to protect against a fire hazard, whereas the purpose of a GFCI is to protect people against electrocution.

Mastering the branch-circuit requirements in Article 210 will give you a jump-start toward completing installations that are free of *Code* violations.

Rule #3: 210.8 GFCI Protection

Ground-fault circuit interruption for personnel must be provided as required in 210.8(A) through (D). The ground-fault circuit-interrupter device must be installed at a readily accessible location. [Figure 210–22](#)

Author's Comment:

- According to Article 100, “readily accessible” means capable of being reached quickly without having to climb over or remove obstacles, or resort to portable ladders.

(A) Dwelling Units. GFCI protection is required for all 15A and 20A, 125V receptacles installed in the following locations:

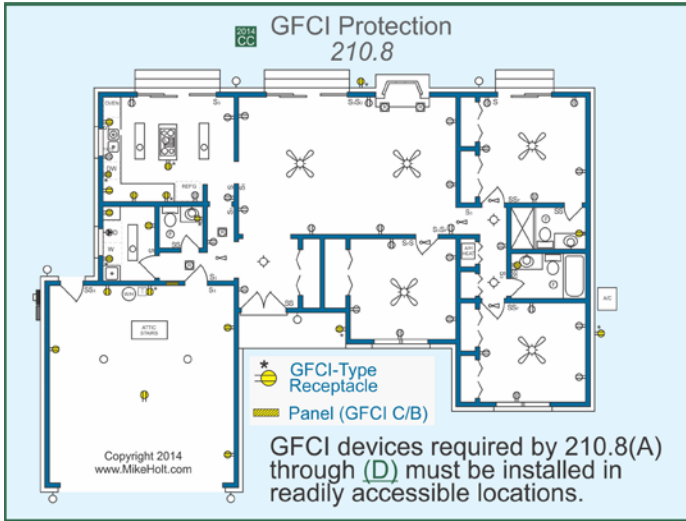

Figure 210-22

Author's Comment:

- See the definitions of “GFCI” and “Dwelling Unit” in Article 100.

(1) Bathroom Area. GFCI protection is required for all 15A and 20A, 125V receptacles in the bathroom area of a dwelling unit. *Figure 210-23*

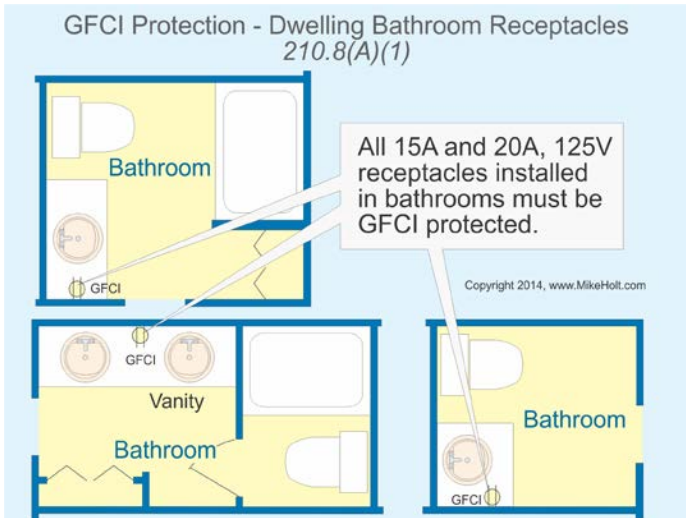

Figure 210-23

Author's Comment:

- See the definition of “Bathroom” in Article 100.
- In the continued interests of safety, proposals to allow receptacles for dedicated equipment in the bathroom area to be exempted from the GFCI protection requirements have been rejected.

(2) Garages and Accessory Buildings. GFCI protection is required for all 15A and 20A, 125V receptacles in garages, and in grade-level portions of accessory buildings used for storage or work areas of a dwelling unit. *Figure 210-24*

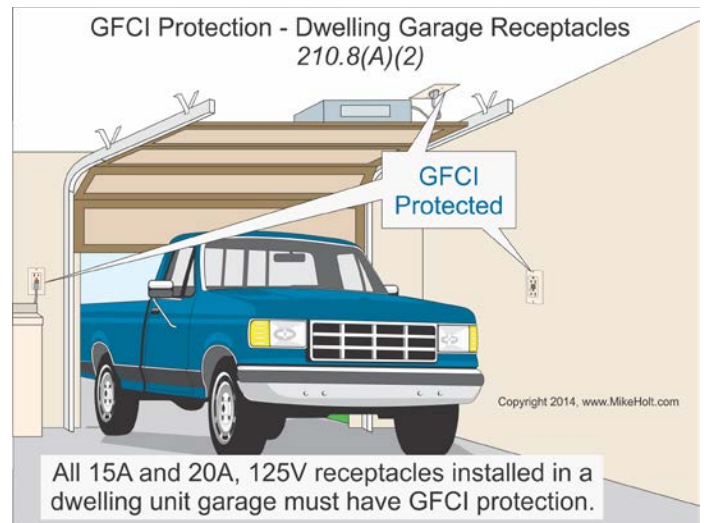

Figure 210-24

Author's Comment:

- See the definition of “Garage” in Article 100.
- A receptacle outlet is required in a dwelling unit attached garage [210.52(G)(1)], but a receptacle outlet isn’t required in an accessory building or a detached garage without power. If a 15A or 20A, 125V receptacle is installed in an accessory building, it must be GFCI protected. *Figure 210-25*

(3) Outdoors. All 15A and 20A, 125V receptacles located outdoors of dwelling units, including receptacles installed under the eaves of roofs, must be GFCI protected. *Figure 210-26*

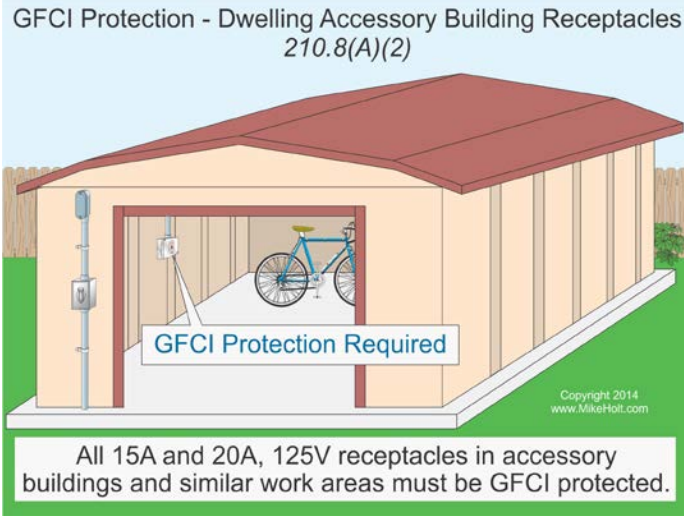

Figure 210–25



Figure 210–26

Author's Comment:

- Each dwelling unit of a multifamily dwelling that has an individual entrance at grade level must have at least one GFCI-protected receptacle outlet accessible from grade level located not more than 6½ ft above grade [210.52(E)(2)].
- Balconies, decks, and porches that are attached to the dwelling unit and are accessible from inside the dwelling must have at least one GFCI-protected receptacle outlet accessible from the balcony, deck, or porch [210.52(E)(3)].

Ex: GFCI protection isn't required for a receptacle that's supplied by a branch circuit dedicated to fixed electric snow-melting or deicing or pipeline and vessel heating equipment, if the receptacle isn't readily accessible and the equipment or receptacle has ground-fault protection of equipment (GFPE) [426.28 and 427.22]. Figure 210–27

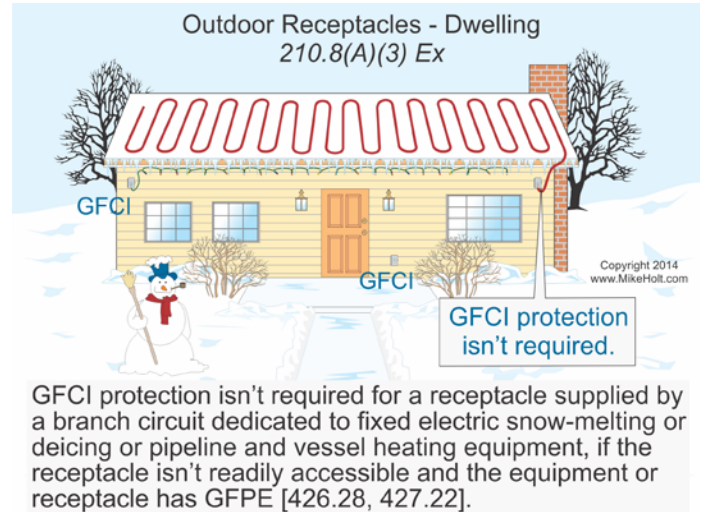

Figure 210–27

(4) Crawl Spaces. All 15A and 20A, 125V receptacles installed in crawl spaces at or below grade of a dwelling unit must be GFCI protected.

Author's Comment:

- The *Code* doesn't require a receptacle to be installed in a crawl space, except when heating, air-conditioning, and refrigeration equipment is installed there [210.63].

(5) Unfinished Basements. GFCI protection is required for all 15A and 20A, 125V receptacles located in the unfinished portion of a basement not intended as a habitable room and limited to storage and work areas. Figure 210–28

Ex: A receptacle supplying only a permanently installed fire alarm or burglar alarm system isn't required to be GFCI protected [760.41(B) and 760.121(B)].

Author's Comment:

- A receptacle outlet is required in each unfinished portion of a dwelling unit basement [210.52(G)(3)].

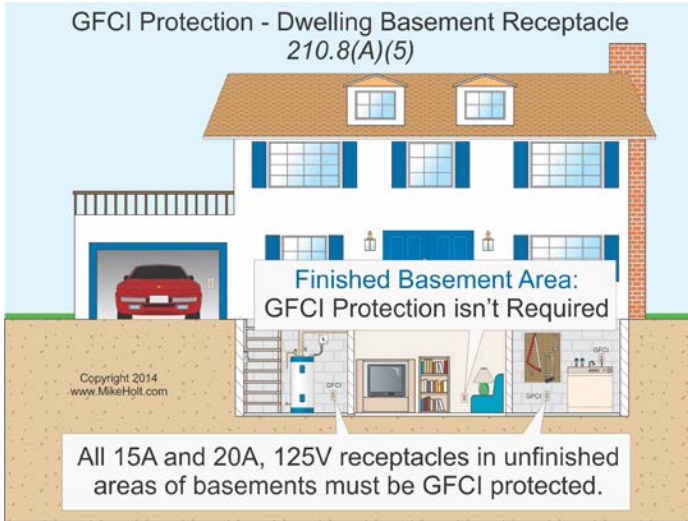

Figure 210-28

(6) Kitchen Countertop Surfaces. GFCI protection is required for all 15A and 20A, 125V receptacles that serve countertop surfaces in a dwelling unit. Figure 210-29

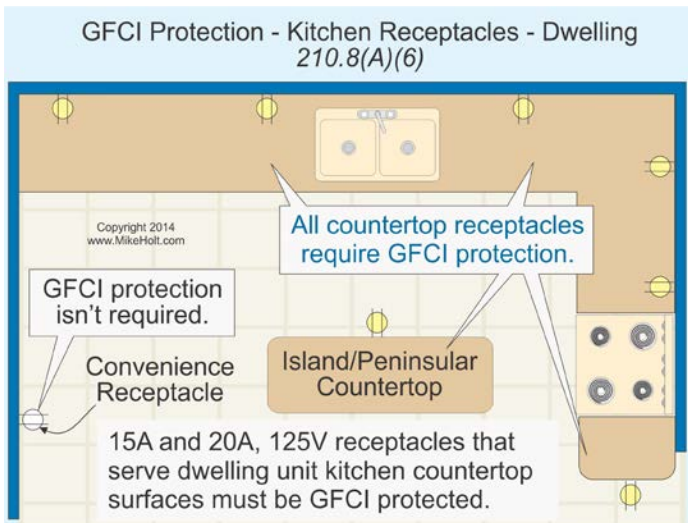

Figure 210-29

Author's Comment:

- See 210.52(C) for the location requirements of countertop receptacles.

(7) Sinks. GFCI protection is required for all 15A and 20A, 125V receptacles located within an arc measurement of 6 ft from the outside edge of a sink. Figures 210-30 and 210-31



Figure 210-30

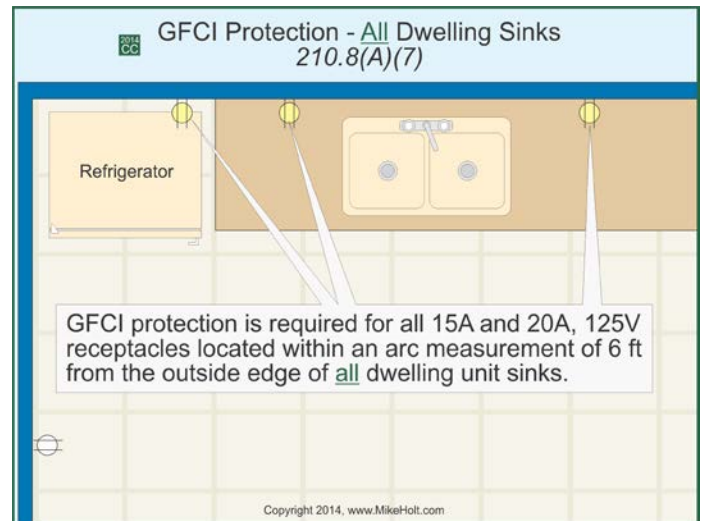

Figure 210-31

(8) Boathouses. GFCI protection is required for all 15A and 20A, 125V receptacles located in a dwelling unit boathouse. Figure 210-32

Author's Comment:

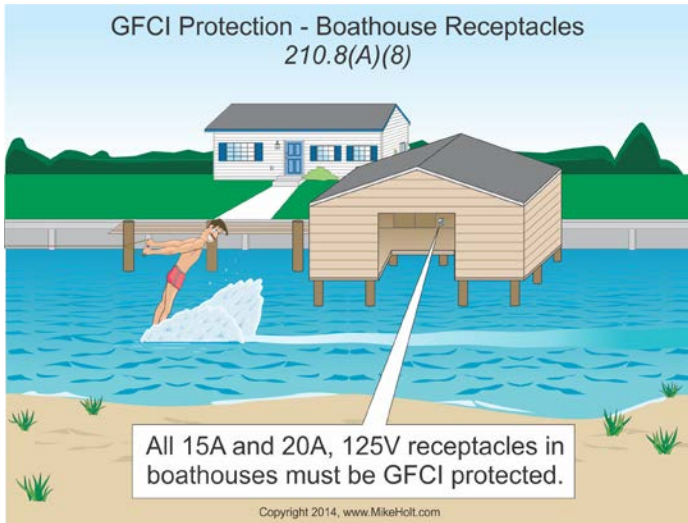

Figure 210-32

- The *Code* doesn't require a 15A or 20A, 125V receptacle to be installed in a boathouse, but if one is installed, it must be GFCI protected.

(9) Bathtubs or Shower Stalls. GFCI protection is required for all 15A and 20A, 125V receptacles located within 6 ft of the outside edge of a bathtub or shower stall. Figure 210-33

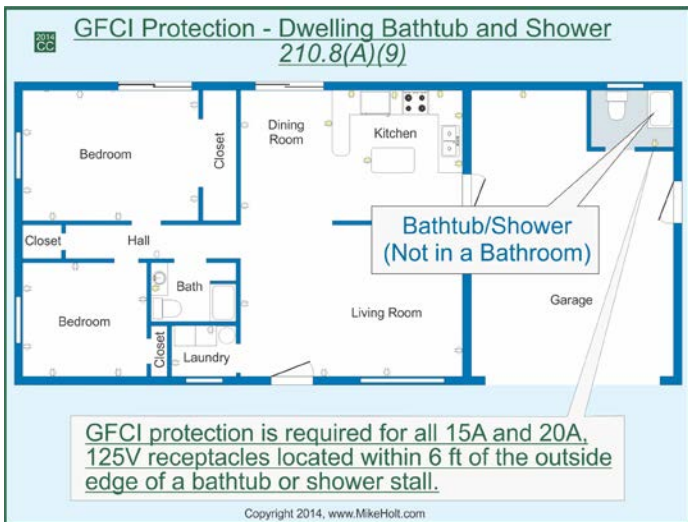

Figure 210-33

(10) Laundry Areas. All 15A and 20A, 125V receptacles installed in laundry areas of a dwelling unit must be GFCI protected. Figure 210-34

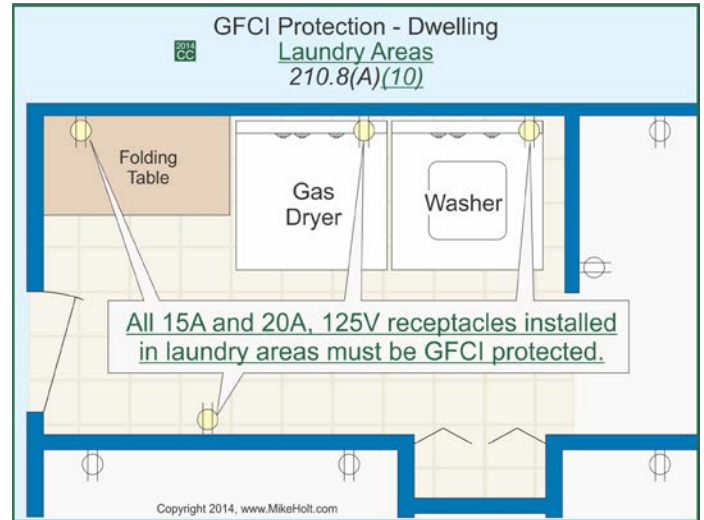

Figure 210-34

(B) Other than Dwelling Units. GFCI protection is required for all 15A and 20A, 125V receptacles installed in the following commercial/industrial locations:

(1) Bathrooms. All 15A and 20A, 125V receptacles installed in commercial or industrial bathrooms must be GFCI protected. Figure 210-35

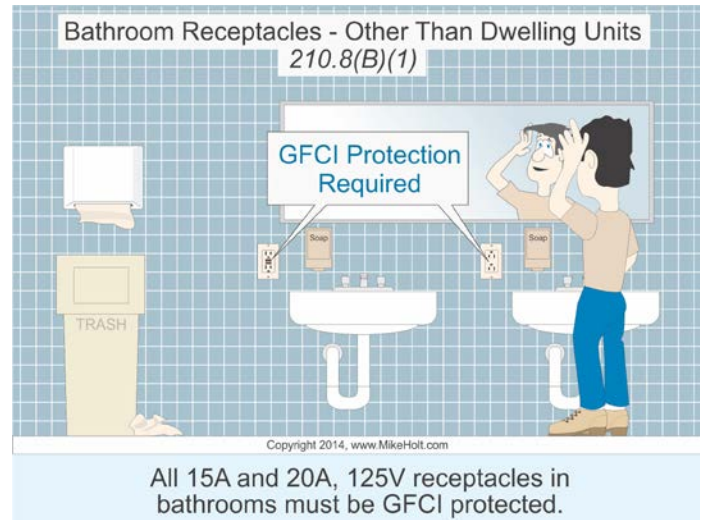

Figure 210-35

Author's Comment:

- See the definition of “Bathroom” in Article 100.
- A 15A or 20A, 125V receptacle isn't required in a commercial or industrial bathroom, but if one is installed, it must be GFCI protected.

(2) Kitchens. All 15A and 20A, 125V receptacles installed in a kitchen, even those that don't supply the countertop surface, must be GFCI protected. *Figure 210-36*

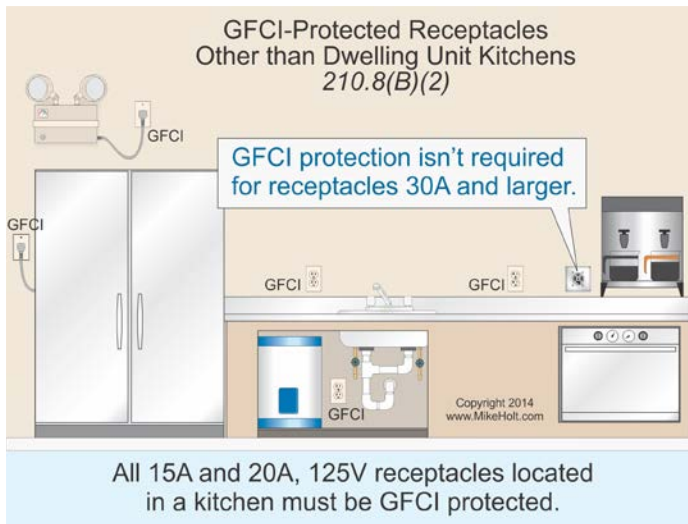

Figure 210-36

Author's Comment:

- A kitchen is an area with a sink and permanent provisions for food preparation and cooking [Article 100]
- GFCI protection isn't required for receptacles rated other than 15A and 20A, 125V in these locations.
- GFCI protection isn't required for hard-wired equipment in these locations.
- An area such as an employee break room with a sink and cord-and-plug-connected cooking appliance such as a microwave oven isn't considered a kitchen. *Figure 210-37*

(3) Rooftops. All 15A and 20A, 125V receptacles installed on rooftops must be GFCI protected. *Figure 210-38*

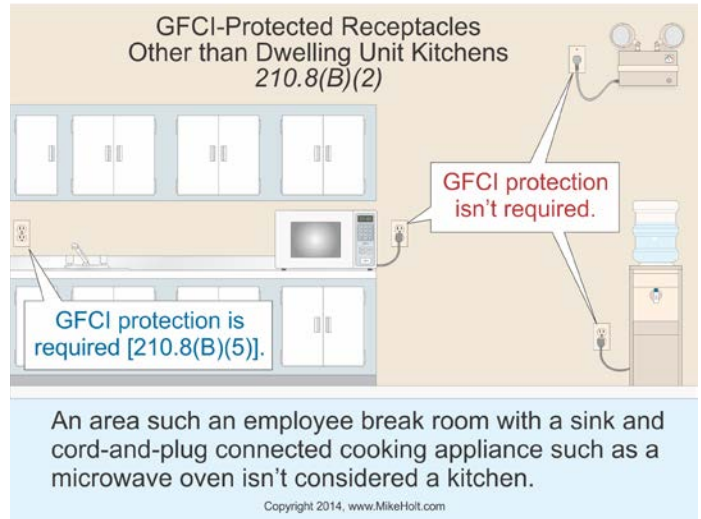

Figure 210-37

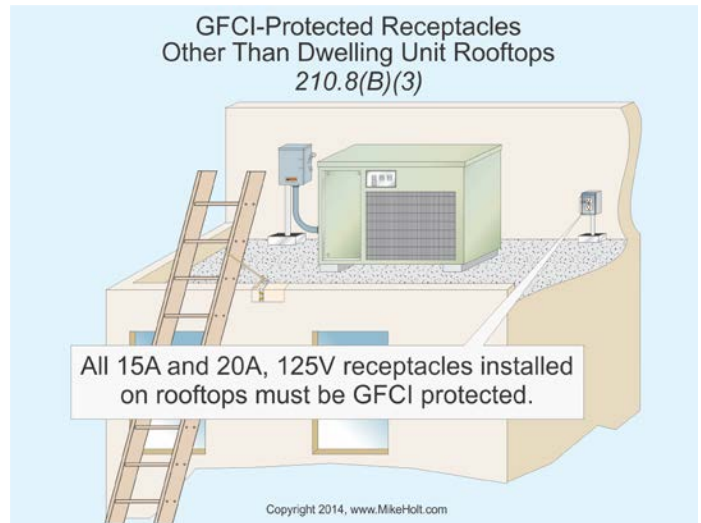

Figure 210-38

Author's Comment:

- A 15A or 20A, 125V receptacle outlet must be installed within 25 ft of heating, air-conditioning, and refrigeration equipment [210.63].

Ex 1 to (3): Receptacles on rooftops aren't required to be readily accessible other than from the rooftop. Figure 210-39



Figure 210-39

(4) Outdoors. All 15A and 20A, 125V receptacles installed outdoors must be GFCI protected. Figure 210-40

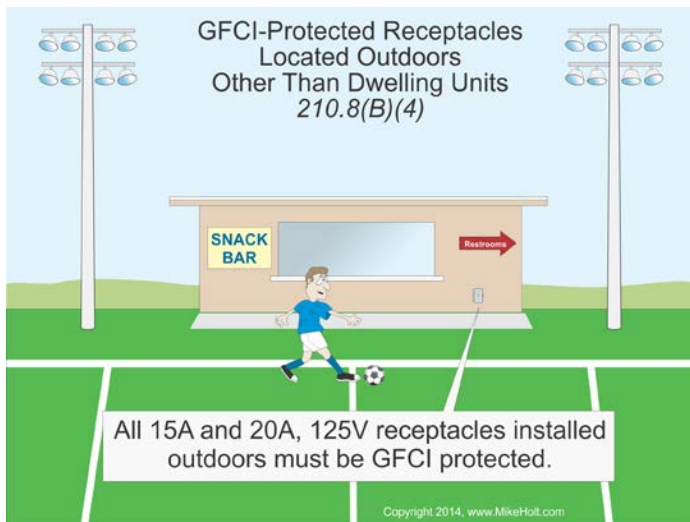

Figure 210-40

Ex 2 to (3) and (4): GFCI protection isn't required for a receptacle that's supplied by a branch circuit dedicated to fixed electric snow-melting or deicing or pipeline and vessel heating equipment, if the receptacle isn't readily accessible and the equipment or receptacle has ground-fault protection of equipment (GFPE) [426.28 and 427.22].

(5) Sinks. All 15A and 20A, 125V receptacles installed within 6 ft of the outside edge of a sink must be GFCI protected. Figure 210-41

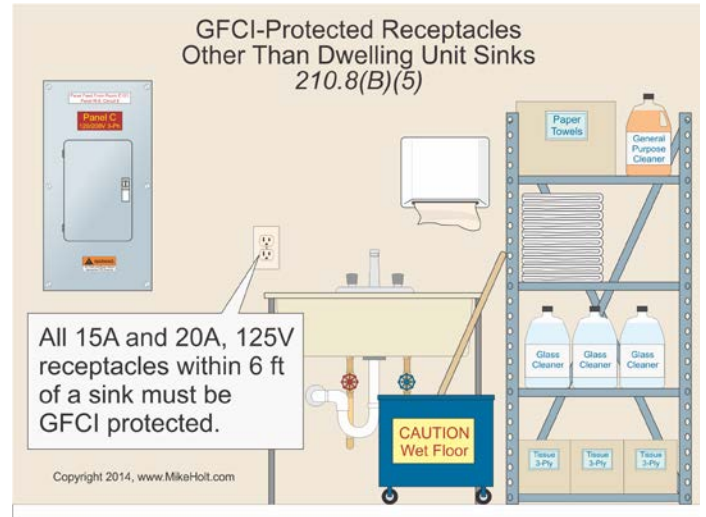

Figure 210-41

Ex 1: In industrial laboratories, receptacles used to supply equipment where removal of power would introduce a greater hazard aren't required to be GFCI protected.

Ex 2: Receptacles located in patient bed locations of general care or critical care areas of health care facilities aren't required to be GFCI protected.

(6) Indoor Wet Locations. All 15A and 20A, 125V receptacles installed indoors in wet locations must be GFCI protected.

(7) Locker Rooms. All 15A and 20A, 125V receptacles installed in locker rooms with associated showering facilities must be GFCI protected.

(8) Garages. All 15A and 20A, 125V receptacles installed in garages, service bays, and similar areas must be GFCI protected, unless they're in show rooms or exhibition halls. Figure 210-42

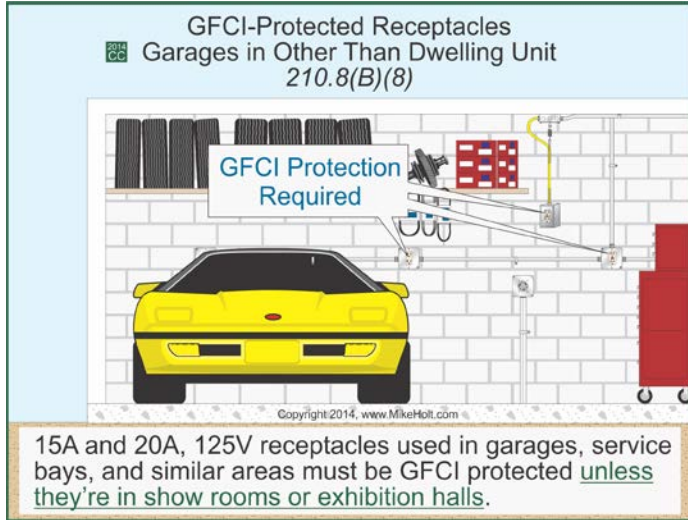

Figure 210-42

(C) Boat Hoists. GFCI protection is required for outlets supplying boat hoists in dwelling unit locations. Figure 210-43

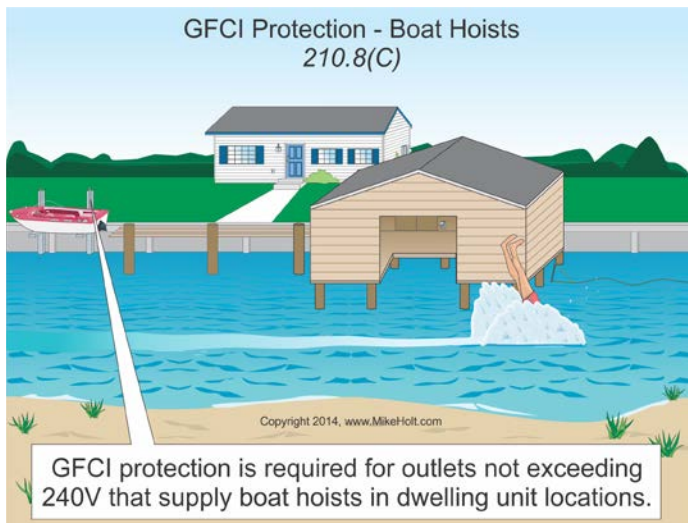

Figure 210-43

Author's Comment:

- See the definition of "Outlet" in Article 100.

- This ensures GFCI protection regardless of whether the boat hoist is cord-and-plug-connected or hard-wired.

(D) Dwelling Unit Dishwashers. Outlets supplying dishwashers in a dwelling unit must be GFCI protected. Figure 210-44



Figure 210-44

Rule #4:
210.12 Arc-Fault
Circuit-Interrupter Protection

Arc-fault circuit-interrupter protection must be provided in accordance with 210.12(A), (B) and (C). AFCI devices must be installed in readily accessible locations.

(A) Where Required. All 15A or 20A, 120V branch circuits in dwelling units supplying outlets or devices in kitchens, family rooms, dining rooms, living rooms, parlors, libraries, dens, bedrooms, sunrooms, recreation rooms, closets, hallways, laundry areas, or similar rooms or areas must be protected by one of the following: Figure 210-53

- (1) A listed combination type AFCI, installed to provide protection of the entire branch circuit.
- (2) A listed branch/feeder type AFCI at the origin of the branch circuit, plus a listed outlet branch-circuit AFCI installed at the first outlet box of the branch circuit. The outlet box must be marked to indicate that it's the first outlet box of the circuit.

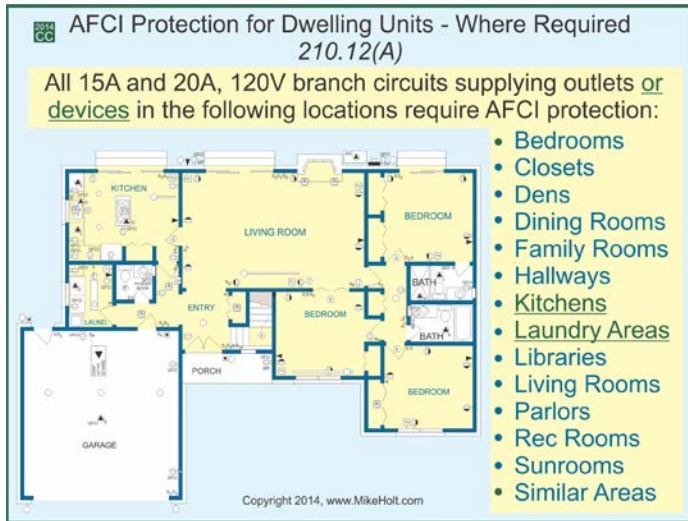

Figure 210-53

(3) A listed supplemental arc protection circuit breaker installed at the origin of the branch circuit, plus a listed outlet branch-circuit type AFCI installed at the first outlet box on the branch circuit. When using this option, the following must be met:

- (a) The branch-circuit wiring must be continuous from the branch circuit overcurrent device to the AFCI device.
 - (b) The maximum length of the branch circuit to the AFCI is 50 ft for 14 AWG conductors or 70 ft for 12 AWG conductors.
 - (c) The first outlet box in the circuit must be marked.
- (4) A regular fuse or circuit breaker, plus a listed outlet branch-circuit type AFCI installed at the first outlet of the branch circuit. When using this option, the following must be met:
- (a) The branch-circuit wiring must be continuous from the branch-circuit overcurrent device to the AFCI device.
 - (b) The maximum length of the branch circuit to the AFCI is 50 ft for 14 AWG conductors or 70 ft for 12 AWG conductors.
 - (c) The first outlet box in the circuit must be marked.
 - (d) The combination of the branch-circuit overcurrent device and the AFCI must be listed and identified as meeting the requirements for a “System Combination” type AFCI.
- (5) A listed outlet branch-circuit type AFCI at the first outlet can be used, if the wiring between the overcurrent device and the AFCI contains all metal boxes and is installed using any (or a combination) of the following: RMC, IMC, EMT, Type MC, Type AC cables

meeting the requirements of 250.118, metal wireways, or metal auxiliary gutters.

- (6) A listed outlet branch-circuit type AFCI at the first outlet of the circuit can be used, if the wiring between the overcurrent device and the AFCI is in a raceway with 2 in. of concrete encasement.

Author's Comment:

- The combination AFCI is a circuit breaker that protects downstream branch-circuit wiring as well as cord sets and power-supply cords; an outlet branch-circuit AFCI (receptacle) is installed as the first outlet in a branch circuit to protect downstream branch-circuit wiring, cord sets, and power-supply cords.
- The 120V circuit limitation means AFCI protection isn't required for equipment rated 230V, such as a baseboard heater or room air conditioner. For more information, visit www.MikeHolt.com, click on the “Search” link, and then search for “AFCI.”

Ex: AFCI protection can be omitted for an individual branch circuit to a fire alarm system in accordance with 760.41(B) and 760.121(B), if the circuit conductors are installed in metal wireways, metal auxiliary gutters, RMC, IMC, EMT, or steel sheath Type AC or MC cable that qualifies as an equipment grounding conductor in accordance with 250.118, with metal outlet and junction boxes.

Note 3: See 760.41(B) and 760.121(B) for power-supply requirements for fire alarm systems.

Author's Comment:

- Smoke alarms connected to a 15A or 20A circuit in a dwelling unit must be AFCI protected if the smoke alarm is located in one of the areas specified in 210.12(A). The exemption from AFCI protection for the “fire alarm circuit” contained in 760.41(B) and 760.121(B) doesn't apply to the single- or multiple-station smoke alarm circuit typically installed in dwelling unit bedroom areas. This is because a smoke alarm circuit isn't a fire alarm circuit as defined in NFPA 72, *National Fire Alarm Code*. Unlike single- or multiple-station smoke alarms, fire alarm systems are managed by a fire alarm control panel. [Figure 210-54](#)

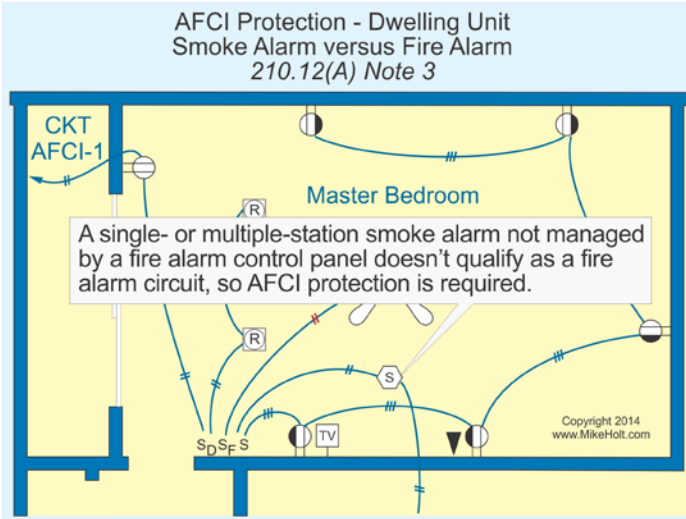

Figure 210-54

(B) Branch-Circuit Extensions or Modifications—Dwelling Units. Where branch-circuit wiring is modified, replaced, or extended in any of the areas specified in 210.12(A), the branch circuit must be protected by:

- (1) A listed combination AFCl located at the origin of the branch circuit; or
- (2) A listed outlet branch circuit AFCl located at the first receptacle outlet of the existing branch circuit.

Ex: AFCl protection isn't required for extensions less than 6 ft long, as long as there are no outlets or devices added.

(C) Dormitory Units. All 120V, single phase, 15A and 20A branch circuits supplying outlets installed in dormitory unit bedrooms, living rooms, hallways, closets, and similar rooms must be AFCl protected by one of the methods discussed in 210.12(A)(1) through (6).

ARTICLE 240

OVERCURRENT PROTECTION

Introduction to Article 240—Overcurrent Protection

This article provides the requirements for selecting and installing overcurrent devices. Overcurrent exists when current exceeds the rating of equipment or the ampacity of a conductor, due to an overload, short circuit, or ground fault [Article 100].

- **Overload.** An overload is a condition where equipment or conductors carry current exceeding their current rating [Article 100]. A fault, such as a short circuit or ground fault, isn't an overload. An example of an overload is plugging two 12.50A (1,500W) hair dryers into a 20A branch circuit.
- **Short Circuit.** A short circuit is the unintentional electrical connection between any two normally current-carrying conductors of an electrical circuit, either line-to-line or line-to-neutral.
- **Ground Fault.** A ground fault is an unintentional, electrically conducting connection between an ungrounded conductor of an electrical circuit and the normally noncurrent-carrying conductors, metallic enclosures, metallic raceways, metallic equipment, or the earth [Article 100]. During the period of a ground fault, dangerous voltages will be present on metal parts until the circuit overcurrent device opens.

Overcurrent devices protect conductors and equipment. Selecting the proper overcurrent protection for a specific circuit can become more complicated than it sounds. The general rule for overcurrent protection is that conductors must be protected in accordance with their ampacities at the point where they receive their supply [240.4 and 240.21]. There are many special cases that deviate from this basic rule, such as the overcurrent protection limitations for small conductors [240.4(D)] and the rules for specific conductor applications found in other articles, as listed in Table 240.4(G). There are also a number of rules allowing tap conductors in specific situations [240.21(B)]. Article 240 even has limits on where overcurrent devices are allowed to be located [240.24].

An overcurrent protection device must be capable of opening a circuit when an overcurrent situation occurs, and must also have an interrupting rating sufficient to avoid damage in fault conditions [110.9]. Carefully study the provisions of this article to be sure you provide sufficient overcurrent protection in the correct location.

Part II. Location

Rule #5: 240.21 Overcurrent Protection Location in Circuit

Except as permitted by (A) through (H), overcurrent devices must be placed at the point where the branch-circuit or feeder conductors receive their power. Taps and transformer secondary conductors aren't permitted to supply another conductor (tapping a tap isn't permitted).

Figure 240–20

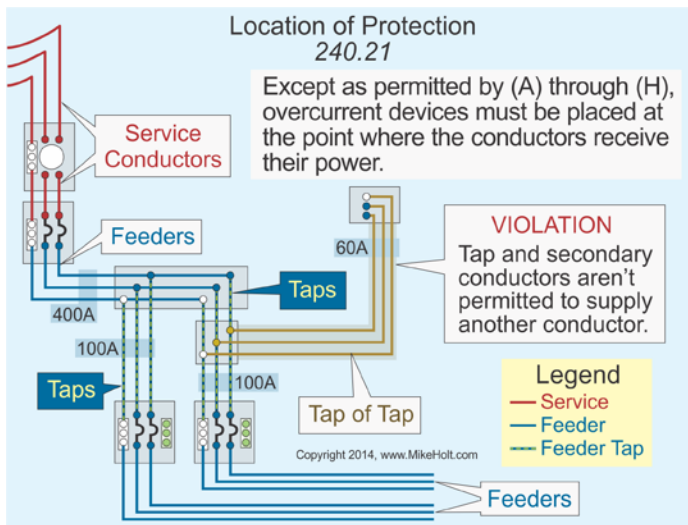

Figure 240–20

(A) Branch-Circuit Taps. Branch-circuit taps are permitted in accordance with 210.19.

(B) Feeder Taps. Conductors can be tapped to a feeder as specified in 240.21(B)(1) through (B)(5). The “next size up protection rule” of 240.4(B) isn't permitted for tap conductors. [Figure 240–21](#)

(1) 10-Footer Feeder Tap. Feeder tap conductors up to 10 ft long are permitted without overcurrent protection at the tap location if the tap conductors comply with the following:

- (1) The ampacity of the tap conductor must not be less than: [Figure 240–22](#)
 - a. The calculated load in accordance with Article 220, and
 - b. The rating of the overcurrent device supplied by the tap conductors.

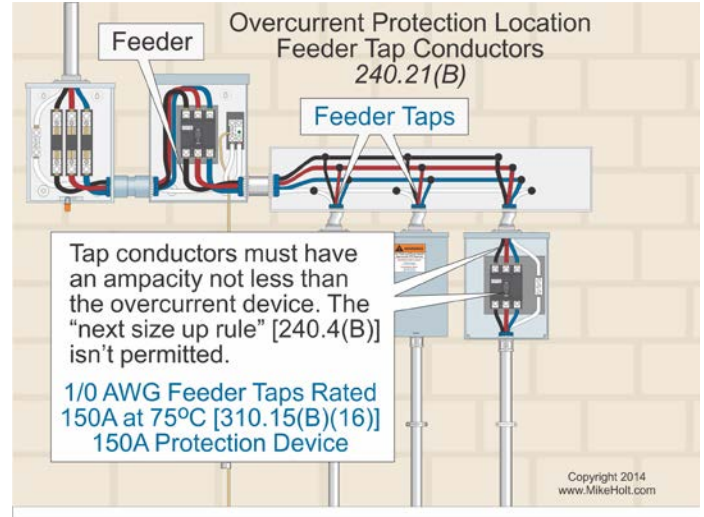

Figure 240–21

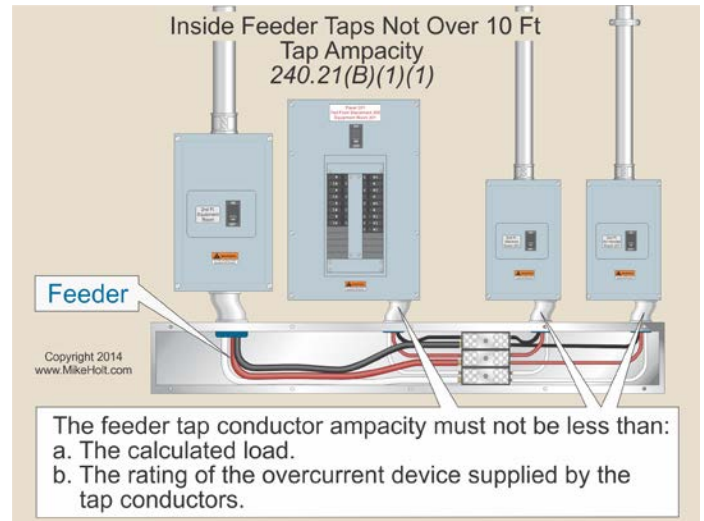

Figure 240–22

Ex: Listed equipment, such as a surge protection device, can have their conductors sized in accordance with the manufacturer's instructions.

- (2) The tap conductors must not extend beyond the equipment they supply.
- (3) The tap conductors are installed in a raceway when they leave the enclosure.
- (4) The tap conductors must have an ampacity not less than 10 percent of the rating of the overcurrent device that protects the feeder.

Figure 240–23

Note: See 408.36 for the overcurrent protection requirements for panelboards.

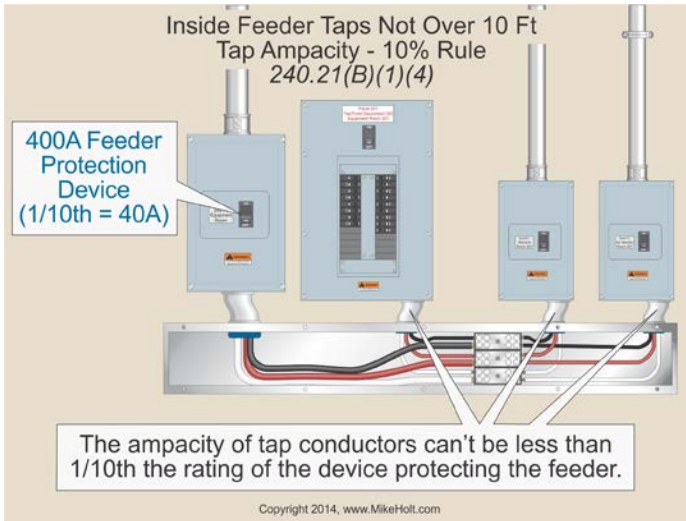

Figure 240–23

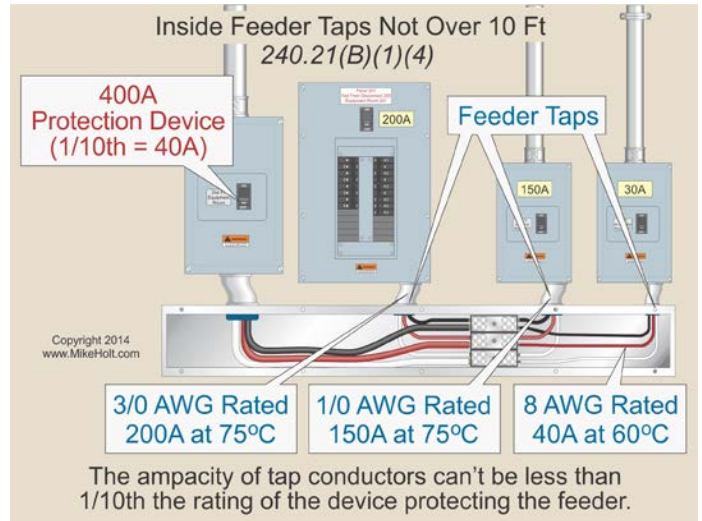

Figure 240–24

Ten-Foot Tap Rule

Example: A 400A breaker protects a set of 500 kcmil feeder conductors. There are three taps fed from the 500 kcmil feeder that supply disconnects with 200A, 150A, and 30A overcurrent devices. What are the minimum size conductors for these taps?

Figure 240–24

- 200A: 3/0 AWG is rated 200A at 75°C, and is greater than 10 percent of the rating of the overcurrent device (400A).
- 150A: 1/0 AWG is rated 150A at 75°C, and is greater than 10 percent of the rating of the overcurrent device (400A).
- 30A: 8 AWG rated 40A at 60°C. The tap conductors from the 400A feeder to the 30A overcurrent device can't be less than 40A (10 percent of the rating of the 400A feeder overcurrent device).

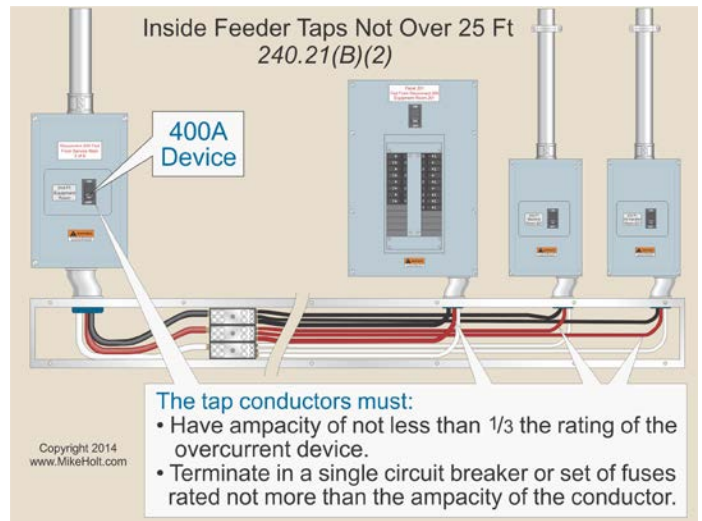

Figure 240–25

(2) 25-Foot Feeder Tap. Feeder tap conductors up to 25 ft long are permitted without overcurrent protection at the tap location if the tap conductors comply with the following: Figures 240–25 and 240–26

- (1) The ampacity of the tap conductors must not be less than one-third the rating of the overcurrent device that protects the feeder.
- (2) The tap conductors terminate in an overcurrent device rated no more than the tap conductor ampacity in accordance with 310.15.

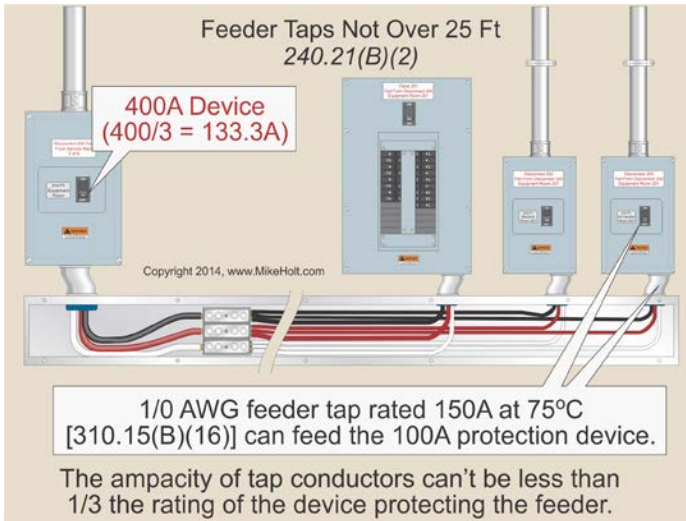

Figure 240–26

(5) Outside Feeder Taps of Unlimited Length. Outside feeder tap conductors can be of unlimited length, without overcurrent protection at the point they receive their supply, if they comply with the following:

Figure 240–27

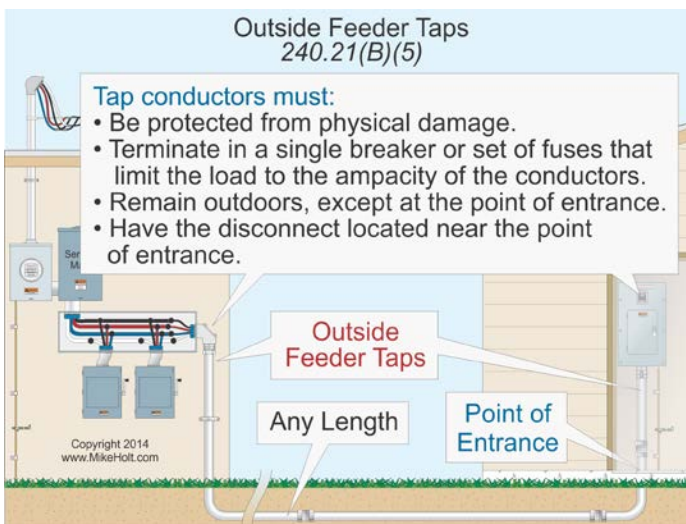

Figure 240–27

- (1) The tap conductors are suitably protected from physical damage in a raceway or manner approved by the authority having jurisdiction.
- (2) The tap conductors must terminate at a single circuit breaker or a single set of fuses that limits the load to the ampacity of the conductors.

- (3) The overcurrent device for the tap conductors is an integral part of the disconnecting means, or it's located immediately adjacent to it.
- (4) The disconnecting means is located at a readily accessible location, either outside the building, or nearest the point of entry of the conductors.

(C) Transformer Secondary Conductors. A set of conductors supplying single or separate loads is permitted to be connected to a transformer secondary without overcurrent protection in accordance with (1) through (6).

The permission of the “next size up” protection rule when the conductor ampacity doesn't correspond with the standard size overcurrent protection device of 240.4(B) doesn't apply to transformer secondary conductors. **Figure 240–28**

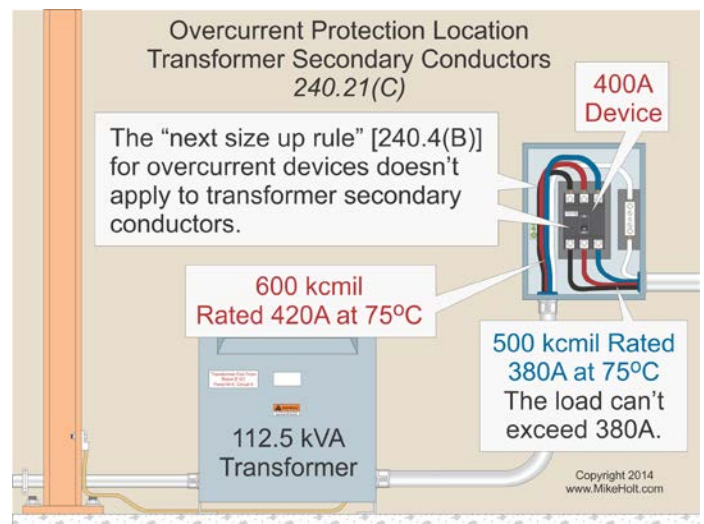

Figure 240–28

(1) Protection by Primary Overcurrent Device. The primary overcurrent device sized in accordance with 450.3(B) is considered suitable to protect the secondary conductors of a 2-wire (single-voltage) system, provided the primary overcurrent device doesn't exceed the value determined by multiplying the secondary conductor ampacity by the secondary-to-primary transformer voltage ratio.

Question: What's the minimum size secondary conductor required for a 2-wire, 480V to 120V transformer rated 1.50 kVA with 60°C terminals? **Figure 240–29**

- (a) 16 AWG (b) 14 AWG (c) 12 AWG (d) 10 AWG

Answer: (c) 12 AWG

Primary Current = VA/E

$VA = 1,500 \text{ VA}$

$E = 480V$

$\text{Primary Current} = 1,500 \text{ VA}/480V$

$\text{Primary Current} = 3.13A$

$\text{Primary Protection [450.3(B)]} = 3.13A \times 1.67$

$\text{Primary Protection [450.3(B)]} = 5.22A \text{ or } 5A \text{ Fuse}$

$\text{Secondary Current} = 1,500 \text{ VA}/120V$

$\text{Secondary Current} = 12.50A$

Secondary Conductor = 12 AWG, rated 20A at 60°C, [Table 310.15(B)(16)]

The 5A primary overcurrent device can be used to protect 12 AWG secondary conductors because it doesn't exceed the value determined by multiplying the secondary conductor ampacity by the secondary-to-primary transformer voltage ratio.

$5A < \text{or} = 20A \times 120V/480V$

$5A < \text{or} = 20A \times (0.25)$

$5A < \text{or} = 5A$

(2) 10 Ft Secondary Conductors. Secondary conductors can be run up to 10 ft without overcurrent protection if installed as follows:

- (1) The ampacity of the secondary conductor must not be less than: **Figure 240–30**
- The calculated load in accordance with Article 220, and
 - The rating of the overcurrent device at the termination of the secondary conductors

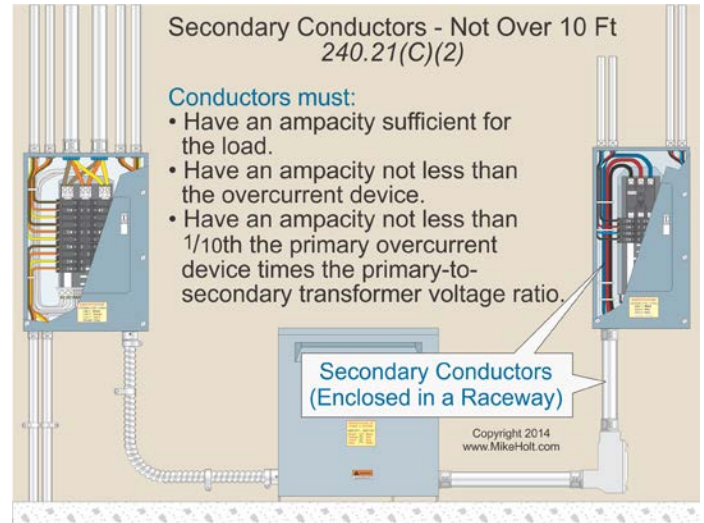

Figure 240–30

Ex: Listed equipment, such as a surge protection device, can have their conductors sized in accordance with the manufacturer's instructions.

- The secondary conductors must not extend beyond the switchboard, **switchgear**, panelboard, disconnecting means, or control devices they supply.
- The secondary conductors are enclosed in a raceway.
- Not less than 10 percent of the rating of the overcurrent device protecting the primary of the transformer, multiplied by the primary-to-secondary transformer voltage ratio.

(4) Outside Secondary Conductors of Unlimited Length. Outside secondary conductors can be of unlimited length, without overcurrent protection at the point they receive their supply, if they're installed as follows: **Figure 240–31**

- The conductors are suitably protected from physical damage in a raceway or manner approved by the authority having jurisdiction.

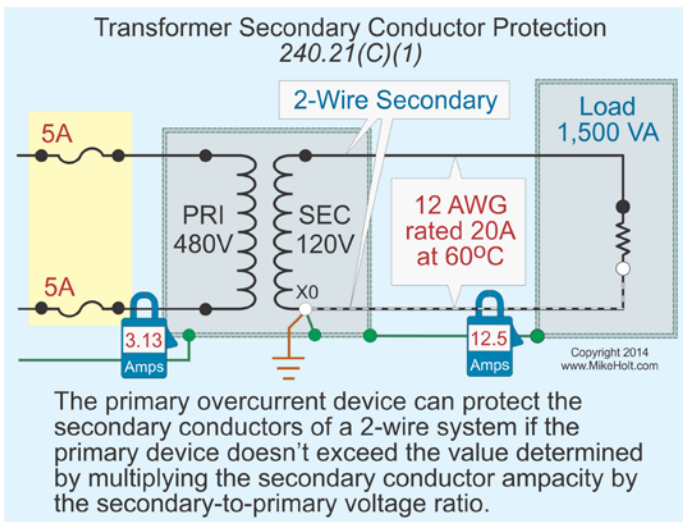

Figure 240–29

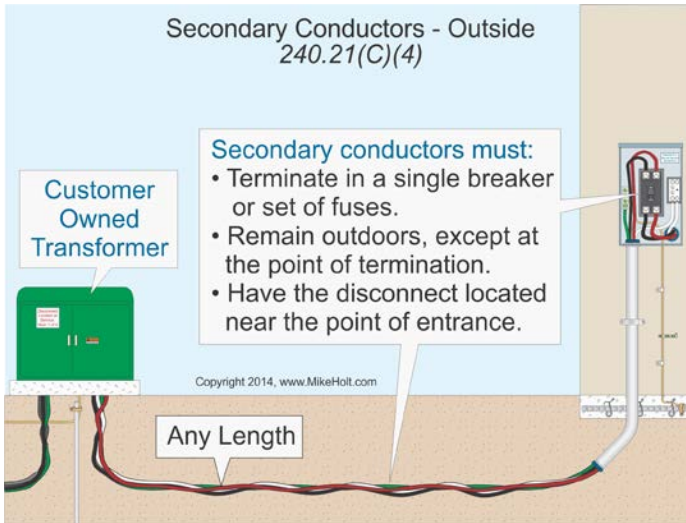

Figure 240-31

- (2) The conductors must terminate at a single circuit breaker or a single set of fuses that limit the load to the ampacity of the conductors.
- (3) The overcurrent device for the ungrounded conductors is an integral part of a disconnecting means or it's located immediately adjacent thereto.
- (4) The disconnecting means is located at a readily accessible location that complies with one of the following:
 - a. Outside of a building.
 - b. Inside, nearest the point of entrance of the conductors.
 - c. If installed in accordance with 230.6, nearest the point of entrance of the conductors.

(5) Secondary Conductors from a Feeder Tapped Transformer.

Transformer secondary conductors must be installed in accordance with 240.21(B)(3).

(6) 25-Foot Secondary Conductor. Secondary conductors can be run up to 25 ft without overcurrent protection if they comply with all of the following: Figure 240-32

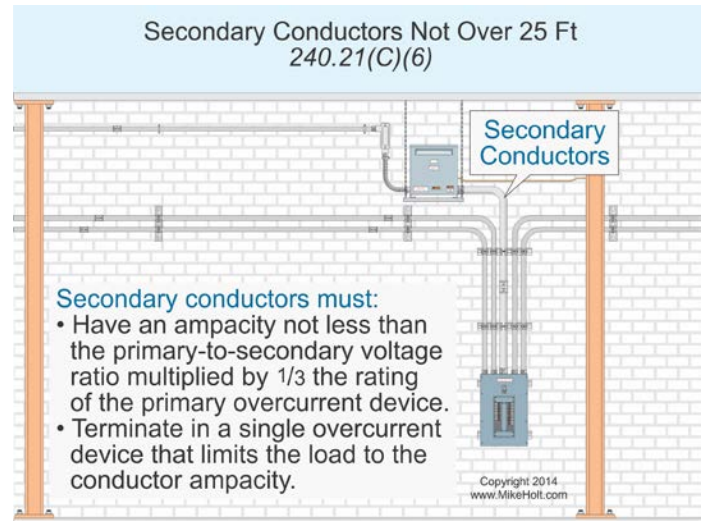

Figure 240-32

- (1) The secondary conductors have an ampacity not less than the value of the primary-to-secondary voltage ratio multiplied by one-third of the rating of the overcurrent device that protects the primary of the transformer.
- (2) Secondary conductors terminate in a single circuit breaker or set of fuses rated no more than the tap conductor ampacity in accordance with 310.15 [Table 310.15(B)(16)].
- (3) The secondary conductors are protected from physical damage by being enclosed in a manner approved by the authority having jurisdiction, such as within a raceway.

(D) Service Conductors. Service conductors must be protected against overload in accordance with 230.90 and 91.

(H) Battery Conductors. Overcurrent protection is installed as close as practicable to the storage battery terminals.

ARTICLE 250

GROUNDING AND BONDING

Introduction to Article 250—Grounding and Bonding

No other article can match Article 250 for misapplication, violation, and misinterpretation. Terminology used in this article has been a source for much confusion, but that has improved during the last few *NEC* revisions. It's very important to understand the difference between grounding and bonding in order to correctly apply the provisions of Article 250. Pay careful attention to the definitions that apply to grounding and bonding both here and in Article 100 as you begin the study of this important article. Article 250 covers the grounding requirements for providing a path to the earth to reduce overvoltage from lightning, and the bonding requirements for a low-impedance fault current path back to the source of the electrical supply to facilitate the operation of overcurrent devices in the event of a ground fault.

Over the past several *Code* cycles, this article was extensively revised to organize it better and make it easier to understand and implement. It's arranged in a logical manner, so it's a good idea to just read through Article 250 to get a big picture view—after you review the definitions. Next, study the article closely so you understand the details. The illustrations will help you understand the key points.

Part II. System Grounding and Bonding

Rule #6: 250.24 Service Equipment— Grounding and Bonding

(A) Grounded System. Service equipment supplied from a grounded system must have the grounding electrode conductor terminate in accordance with (1) through (5).

(1) Grounding Location. A grounding electrode conductor must connect the service neutral conductor to the grounding electrode at any accessible location, from the load end of the overhead service conductors, service drop, underground service conductors, or service lateral, up to and including the service disconnecting means. **Figure 250–45**

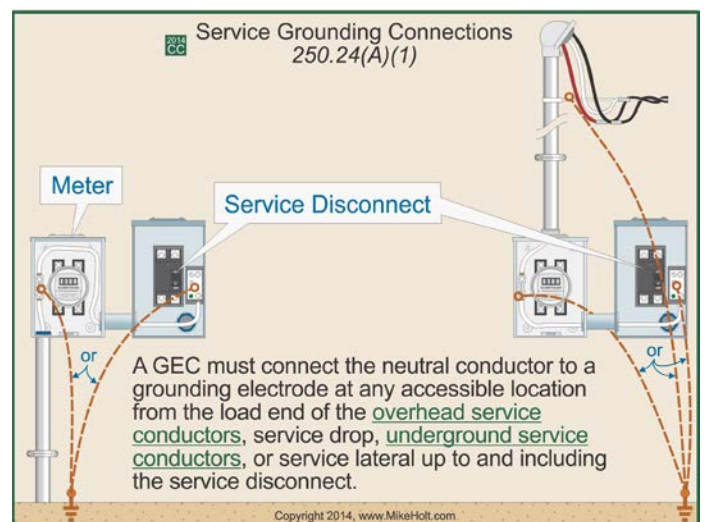

Figure 250–45

Author's Comment:

- Some inspectors require the service neutral conductor to be grounded (connected to the earth) from the meter socket enclosure, while other inspectors insist that it be grounded (connected to the earth) only from the service disconnect. Grounding at either location complies with this rule.

(4) Grounding Termination. When the service neutral conductor is connected to the service disconnecting means [250.24(B)] by a wire or busbar [250.28], the grounding electrode conductor is permitted to terminate to either the neutral terminal or the equipment grounding terminal within the service disconnect.

(5) Neutral-to-Case Connection. A neutral-to-case connection isn't permitted on the load side of service equipment, except as permitted by 250.142(B). [Figure 250-46](#)

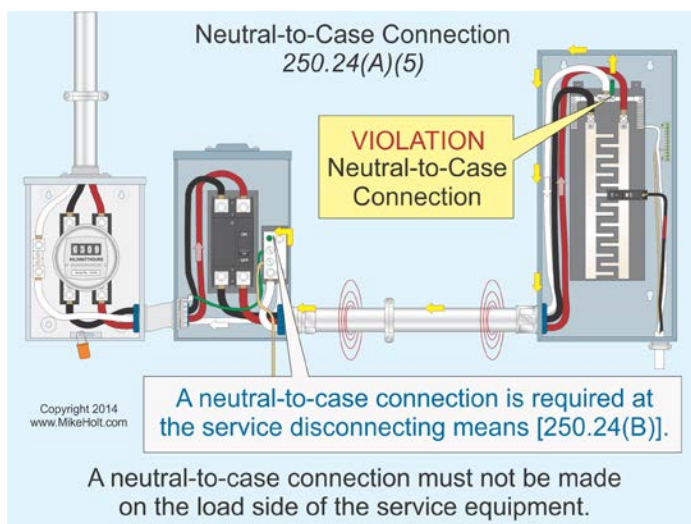

Figure 250-46

Author's Comment:

- If a neutral-to-case connection is made on the load side of service equipment, dangerous objectionable neutral current will flow on conductive metal parts of electrical equipment [250.6(A)]. Objectionable neutral current on metal parts of electrical equipment can cause electric shock and even death from ventricular fibrillation, as well as a fire. [Figures 250-47](#) and [250-48](#)

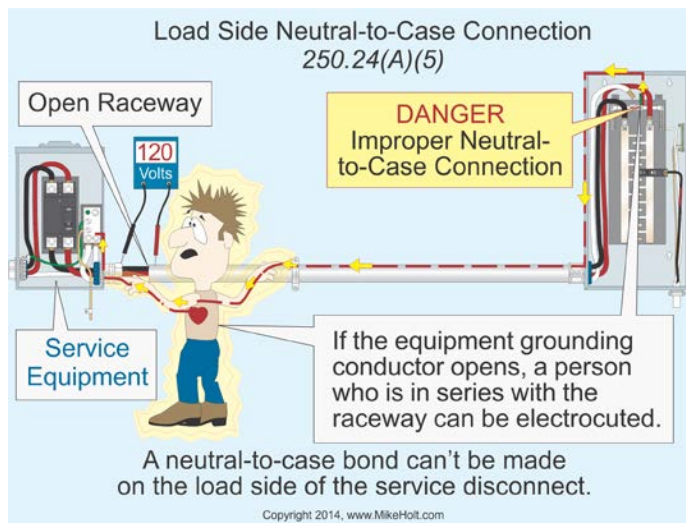

Figure 250-47

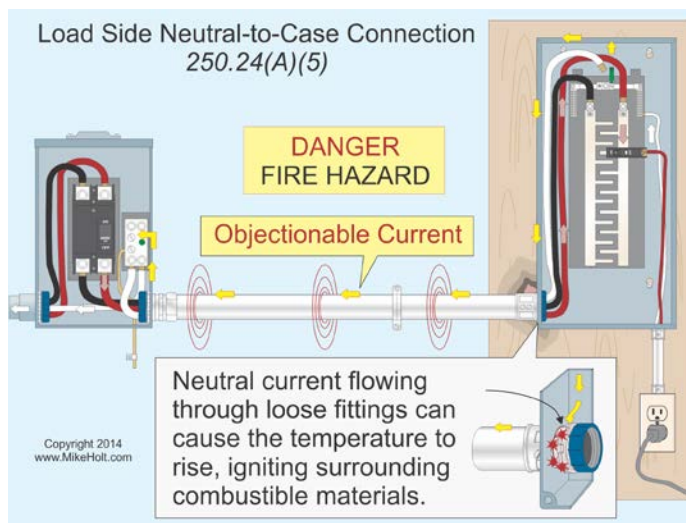

Figure 250-48

(B) Main Bonding Jumper. A main bonding jumper [250.28] is required to connect the neutral conductor to the equipment grounding conductor within the service disconnecting means. [Figures 250-49](#) and [250-50](#)

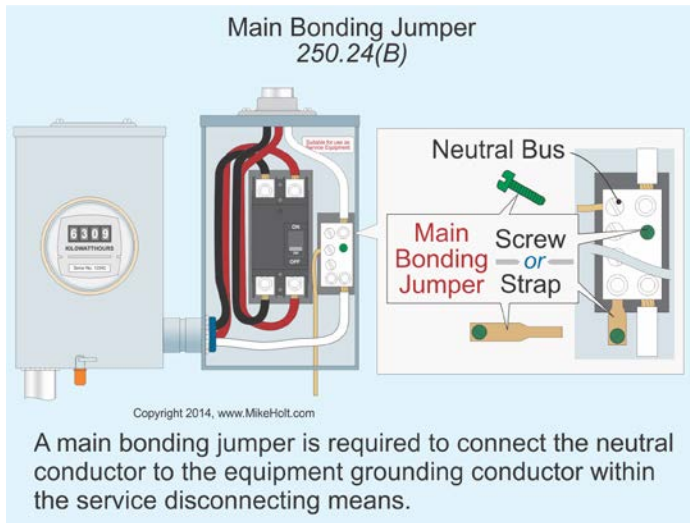

Figure 250-49

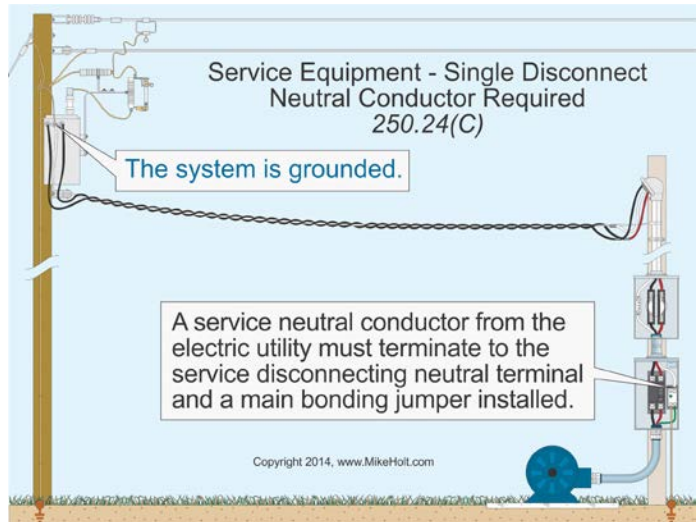

Figure 250-51

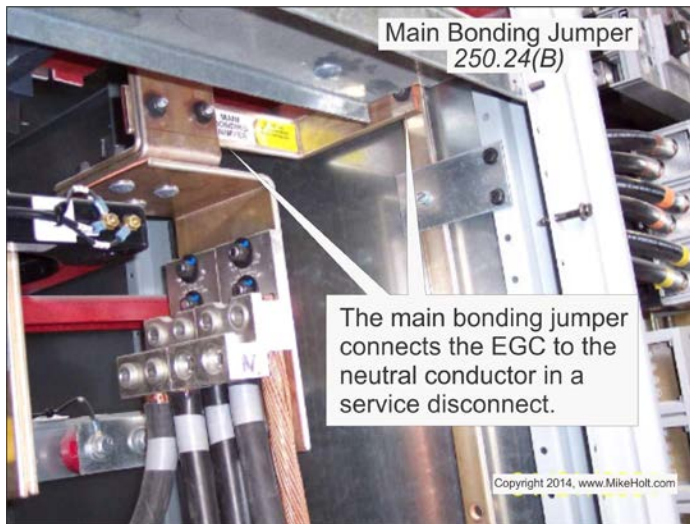

Figure 250-50

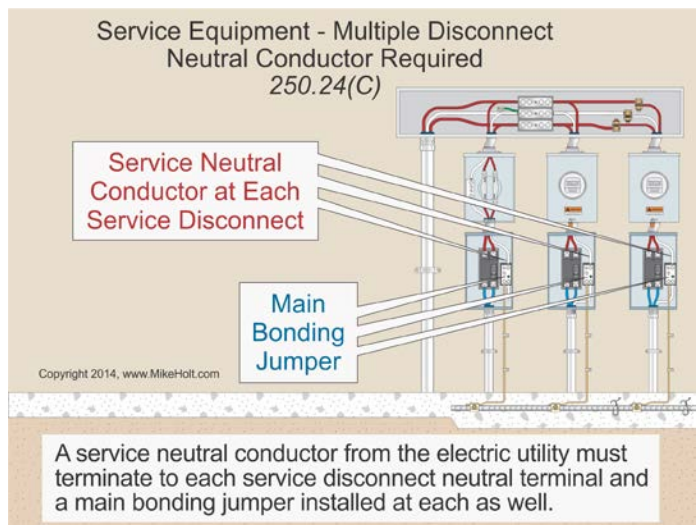

Figure 250-52

(C) Neutral Conductor Brought to Service Equipment. A service neutral conductor must be run from the electric utility supply with the ungrounded conductors and terminate to the service disconnect neutral terminal. A main bonding jumper [250.24(B)] must be installed between the service neutral terminal and the service disconnecting means enclosure [250.28]. *Figures 250-51 and 250-52*

Author's Comment:

- The service neutral conductor provides the effective ground-fault current path to the power supply to ensure that dangerous voltage from a ground fault will be quickly removed by opening the overcurrent device [250.4(A)(3) and 250.4(A)(5)]. *Figure 250-53*

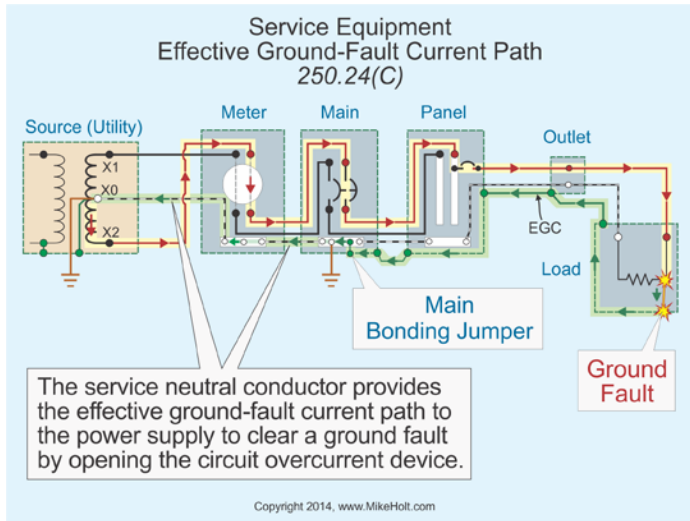

Figure 250-53



DANGER: Dangerous voltage from a ground fault won't be removed from metal parts, metal piping, and structural steel if the service disconnecting means enclosure isn't connected to the service neutral conductor. This is because the contact resistance of a grounding electrode to the earth is so great that insufficient fault current returns to the power supply if the earth is the only fault current return path to open the circuit overcurrent device. Figure 250-54

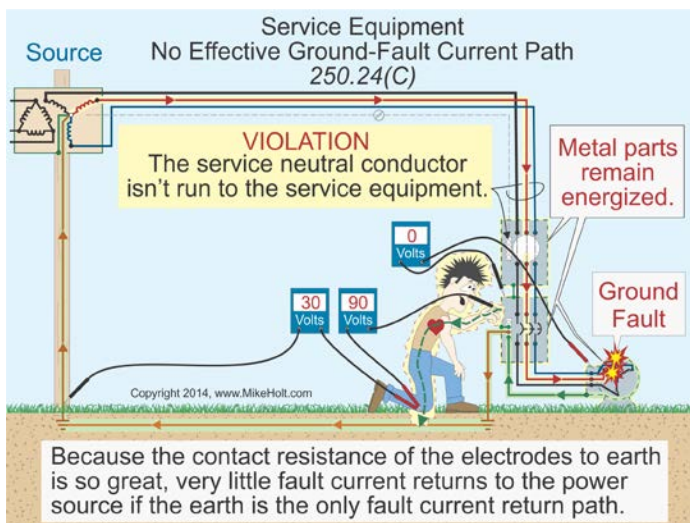

Figure 250-54

Author's Comment:

- If the neutral conductor is opened, dangerous voltage will be present on metal parts under normal conditions, providing the potential for electric shock. If the earth's ground resistance is 25 ohms and the load's resistance is 25 ohms, the voltage drop across each of these resistors will be half of the voltage source. Since the neutral is connected to the service disconnect, all metal parts will be elevated to 60V above the earth's potential for a 120/240V system. Figure 250-55

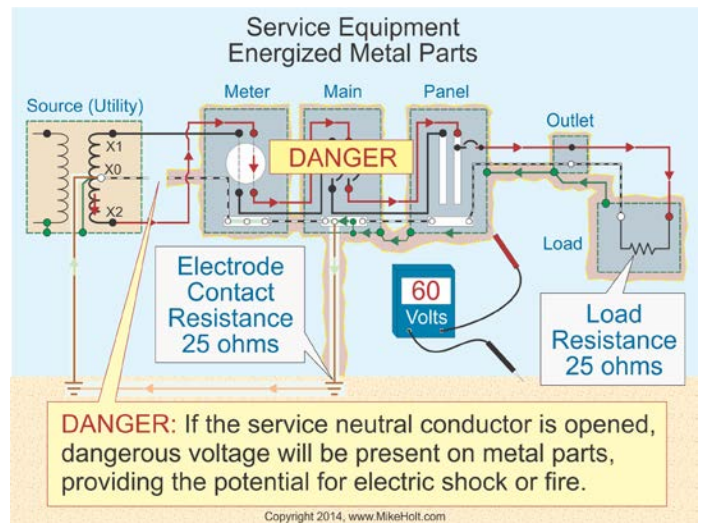

Figure 250-55

- To determine the actual voltage on the metal parts from an open service neutral conductor, you need to do some complex calculations. Visit www.MikeHolt.com and go to the "Free Resources" link to download a spreadsheet for this purpose.

(1) Single Raceway. Because the service neutral conductor serves as the effective ground-fault current path to the source for ground faults, the neutral conductor must be sized so it can safely carry the maximum fault current likely to be imposed on it [110.10 and 250.4(A)(5)]. This is accomplished by sizing the neutral conductor not smaller than specified in Table 250.102(C)(1), based on the cross-sectional area of the largest ungrounded service conductor. Figure 250-56

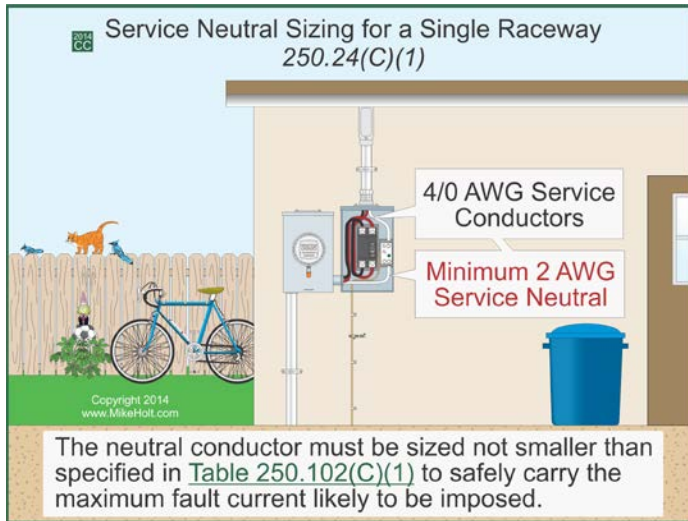

Figure 250-56

Author's Comment:

- In addition, the neutral conductors must have the capacity to carry the maximum unbalanced neutral current in accordance with 220.61.

Question: What's the minimum size service neutral conductor required where the ungrounded service conductors are 350 kcmil and the maximum unbalanced load is 100A? [Figure 250-57](#)

(a) 3 AWG (b) 2 AWG (c) 1 AWG (d) 1/0 AWG

Answer: (b) 2 AWG [Table [250.102\(C\)\(1\)](#)]

The unbalanced load of 100A requires a 3 AWG service neutral conductor, which is rated 100A at 75°C in accordance with Table 310.15(B)(16) [220.61], but the neutral conductor can be smaller than 2 AWG to carry fault current, based on the 350 kcmil ungrounded conductors [Table [250.102\(C\)\(1\)](#)].

(2) Parallel Conductors in Two or More Raceways. If service conductors are paralleled in two or more raceways, a neutral conductor must be installed in each of the parallel raceways. The size of the neutral conductor in each raceway must not be smaller than specified in Table [250.102\(C\)\(1\)](#), based on the cross-sectional area of the largest ungrounded service conductor in each raceway. In no case can the neutral conductor in each parallel set be sized smaller than 1/0 AWG [310.10(H)(1)].

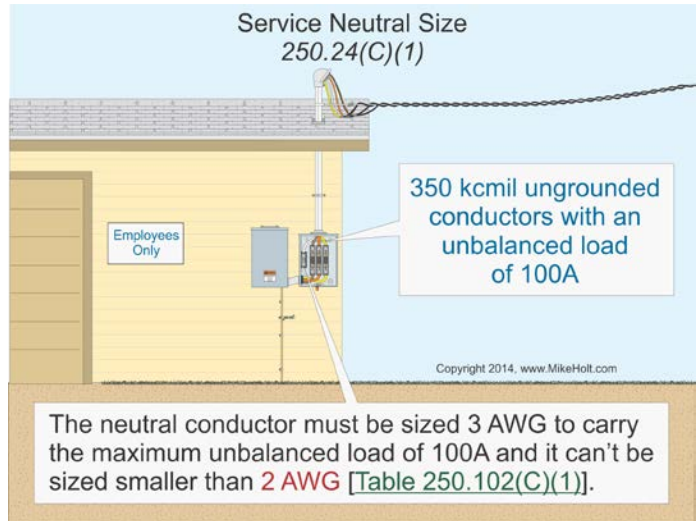

Figure 250-57

Author's Comment:

- In addition, the neutral conductors must have the capacity to carry the maximum unbalanced neutral current in accordance with 220.61.

Question: What's the minimum size service neutral conductor required for each of two raceways, where the ungrounded service conductors in each of the raceways are 350 kcmil and the maximum unbalanced load is 100A? [Figure 250-58](#)

(a) 3 AWG (b) 2 AWG (c) 1 AWG (d) 1/0 AWG

Answer: (d) 1/0 AWG per raceway [Table [250.102\(C\)\(1\)](#) and 310.10(H)]

The unbalanced load of 50A in each raceway requires an 8 AWG service neutral conductor, which is rated 50A at 75°C in accordance with Table 310.15(B)(16) [220.61]. Also, Table [250.102\(C\)\(1\)](#) requires a minimum of 2 AWG in each raceway, however, 1/0 AWG is the smallest conductor permitted to be parallel [310.10(H) and Table 310.15(B)(16)].

(D) Grounding Electrode Conductor. A grounding electrode conductor, sized in accordance with 250.66 based on the area of the ungrounded service conductor, must connect the neutral conductor and metal parts of service equipment enclosures to a grounding electrode in accordance with Part III of Article 250.

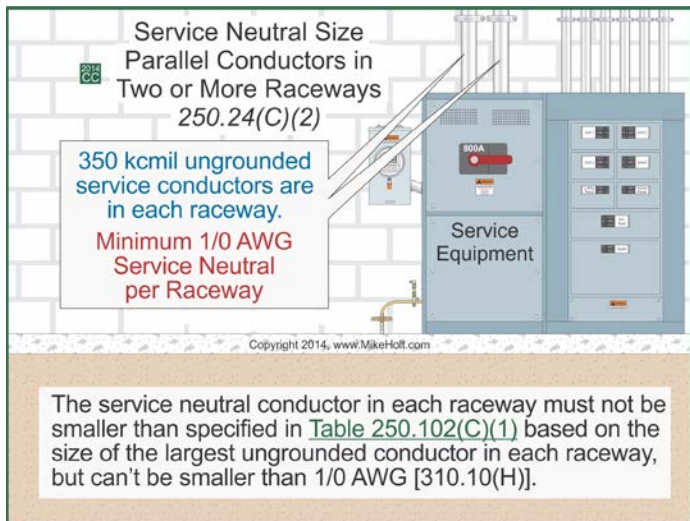

Figure 250-58

Question: What's the minimum size grounding electrode conductor for a 400A service where the ungrounded service conductors are sized at 500 kcmil? **Figure 250-59**

(a) 3 AWG (b) 2 AWG (c) 1 AWG (d) 1/0 AWG

Answer: (d) 1/0 AWG [Table 250.66]

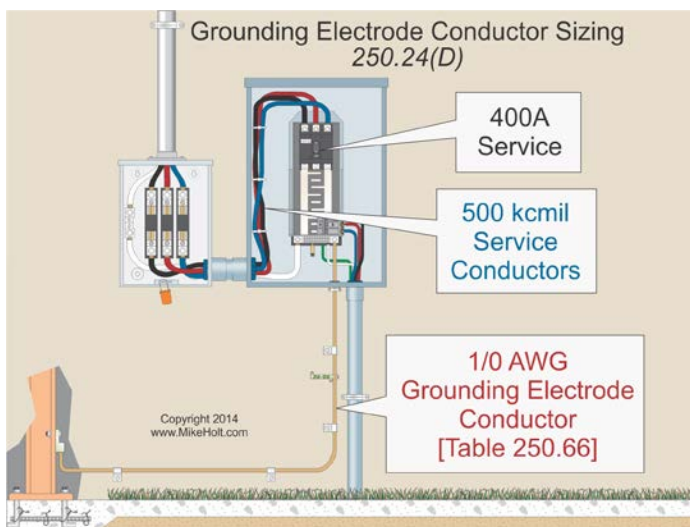

Figure 250-59

Author's Comment:

- If the grounding electrode conductor is connected to a rod(s), the portion of the conductor that's the sole connection to the rod(s) isn't required to be larger than 6 AWG copper [250.66(A)]. **Figure 250-60**

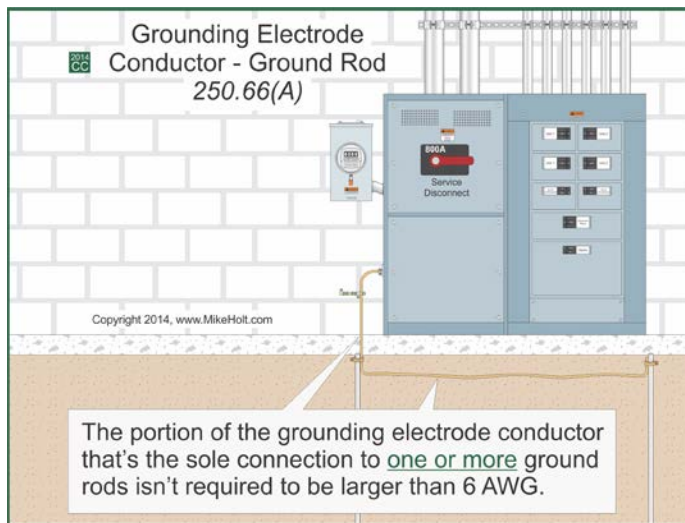

Figure 250-60

- If the grounding electrode conductor is connected to a concrete-encased electrode(s), the portion of the conductor that's the sole connection to the concrete-encased electrode(s) isn't required to be larger than 4 AWG copper [250.66(B)]. **Figure 250-61**

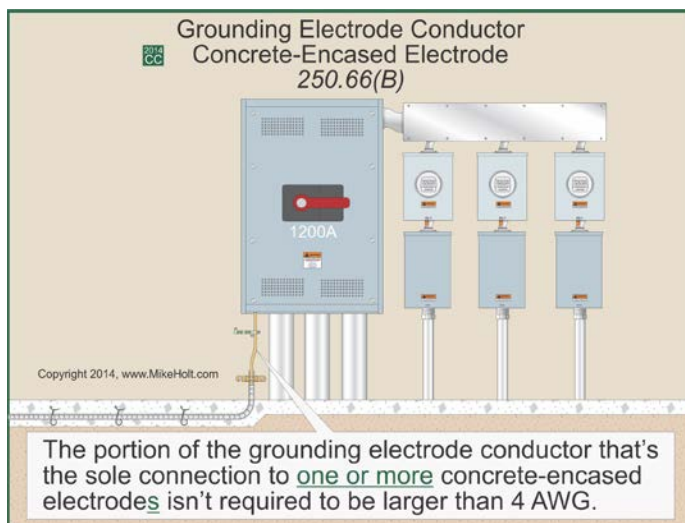

Figure 250-61

Part VI. Equipment Grounding and Equipment Grounding Conductors

Rule #7: 250.122 Sizing Equipment Grounding Conductor

(A) General. Equipment grounding conductors of the wire type must be sized not smaller than shown in Table 250.122, based on the rating of the circuit overcurrent device; however, the circuit equipment grounding conductor isn't required to be larger than the circuit conductors. [Figure 250–209](#)

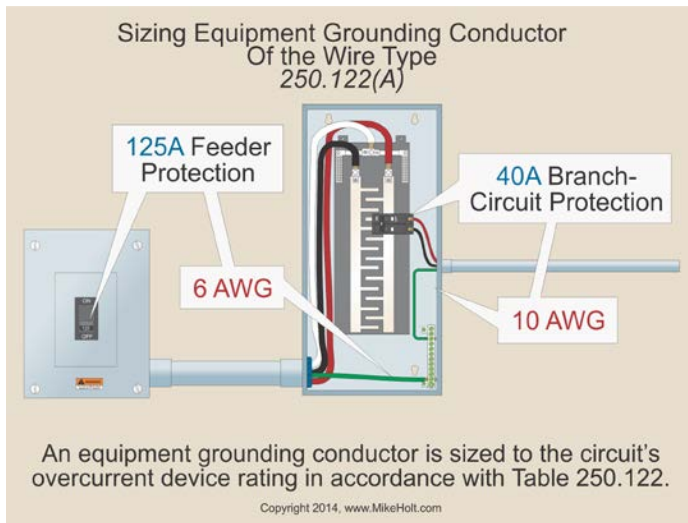

Figure 250–209

(B) Increased in Size. If ungrounded conductors are increased in size from the minimum ampacity that'd be required for the load, wire type equipment grounding conductors must be proportionately increased in size according to the circular mil area of the ungrounded conductors.

Author's Comment:

- Ungrounded conductors are sometimes increased in size to accommodate conductor voltage drop, harmonic current heating, short-circuit rating, or simply for future capacity.

Table 250.122 Sizing Equipment Grounding Conductor

Overcurrent Device Rating	Copper Conductor
15A	14 AWG
20A	12 AWG
25A—60A	10 AWG
70A—100A	8 AWG
110A—200A	6 AWG
225A—300A	4 AWG
350A—400A	3 AWG
450A—500A	2 AWG
600A	1 AWG
700A—800A	1/0 AWG
1,000A	2/0 AWG
1,200A	3/0 AWG

Question: If the ungrounded conductors for a 40A circuit (with 75°C terminals) are increased in size from 8 AWG to 6 AWG due to voltage drop, the circuit equipment grounding conductor must be increased in size from 10 AWG to _____. [Figure 250–210](#)

- (a) 10 AWG (b) 8 AWG (c) 6 AWG (d) 4 AWG

Answer: (b) 8 AWG

The circular mil area of 6 AWG is 59 percent more than 8 AWG (26,240 Cmil/16,510 Cmil) [Chapter 9, Table 8].

According to Table 250.122, the circuit equipment grounding conductor for a 40A overcurrent device will be 10 AWG (10,380 Cmil), but the circuit equipment grounding conductor for this circuit must be increased in size by a multiplier of 1.59.

$$\text{Conductor Size} = 10,380 \text{ Cmil} \times 1.59$$

$$\text{Conductor Size} = 16,504 \text{ Cmil}$$

$$\text{Conductor Size} = 8 \text{ AWG, Chapter 9, Table 8}$$

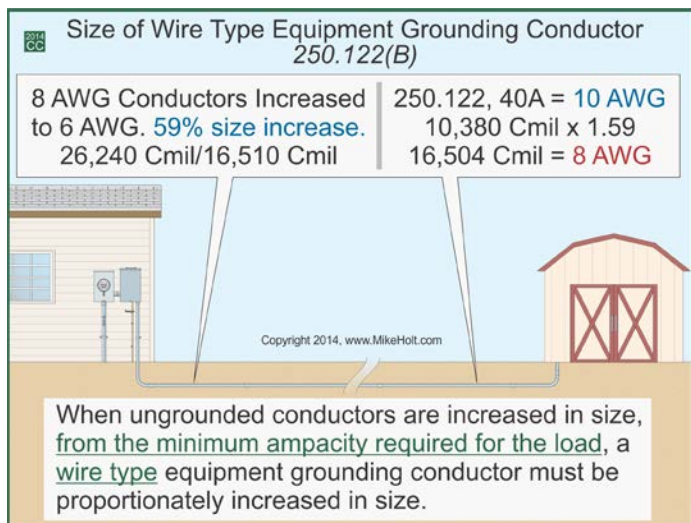

Figure 250–210

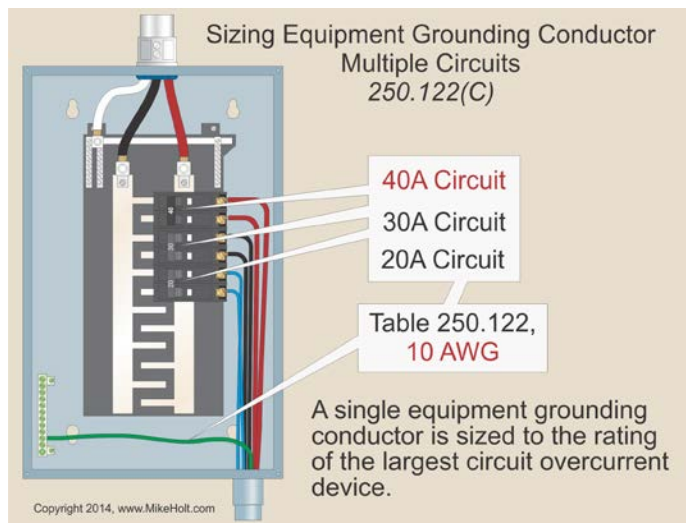

Figure 250–211

Question: If the ungrounded conductors for a 40A circuit (with 60°C terminals) are increased in size from 8 AWG to 6 AWG due to having four current-carrying conductors in a raceway, the circuit equipment grounding conductor must be increased in size from 10 AWG to _____.

(a) An increase isn't required (b) 8 AWG
(c) 6 AWG (d) 4 AWG

Answer: (a) An increase isn't required

The equipment grounding conductor doesn't need to be increased in size in this example, because the 6 AWG is the smallest size ungrounded conductor allowed by the Code.

8 AWG rated 40A at 60°C x 0.80 = 32A after adjustment factors is too small for the circuit example. 6 AWG rated 55A at 60°C, is required (55A x 0.80 = 44A).

(C) Multiple Circuits. When multiple circuits are installed in the same raceway, cable, or cable tray, one equipment grounding conductor sized in accordance with 250.122, based on the rating of the largest circuit overcurrent device is sufficient. [Figure 250–211](#)

(D) Motor Branch Circuits.

(1) General. The equipment grounding conductor of the wire type must be sized in accordance with Table 250.122, based on the rating of the motor circuit branch-circuit short-circuit and ground-fault overcurrent device, but this conductor isn't required to be larger than the circuit conductors [250.122(A)].

Question: What size equipment grounding conductor is required for a 2 hp, 230V, single-phase motor? [Figure 250–212](#)

(a) 14 AWG (b) 12 AWG (c) 10 AWG (d) 8 AWG

Answer: (a) 14 AWG

Step 1: Determine the branch-circuit conductor size [430.22(A) and Table 310.15(B)(16)]
2 hp, 230V Motor FLC = 12A [Table 430.248]
12A x 1.25 = 15A, 14 AWG, rated 20A at 75°C [Table 310.15(B)(16)]

Step 2: Determine the branch-circuit protection [240.6(A), 430.52(C)(1), and Table 430.248]
12A x 2.50 = 30A

Step 3: The circuit equipment grounding conductor must be sized to the 30A overcurrent device—10 AWG [Table 250.122], but it's not required to be sized larger than the circuit conductors—14 AWG.

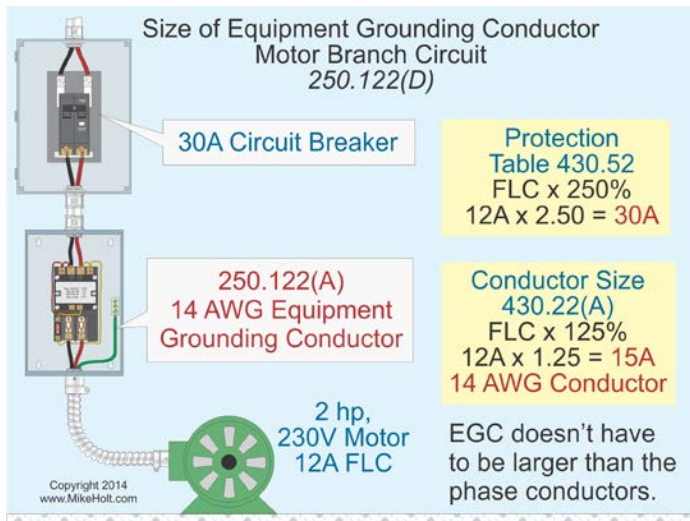

Figure 250-212

(F) Parallel Runs. If circuit conductors are installed in parallel in separate raceways or cable as permitted by 310.10(H), an equipment grounding conductor must be installed for each parallel conductor set. The equipment grounding conductor in each raceway or cable must be sized in accordance with Table 250.122, based on the rating of the circuit overcurrent device, but it's not required to be larger than the circuit conductors [250.122(A)]. Figure 250-213

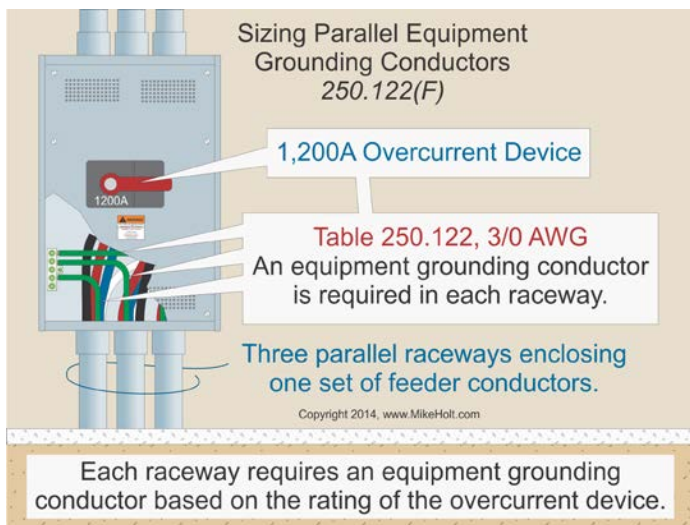

Figure 250-213

(G) Feeder Tap Conductors. Equipment grounding conductors for feeder taps must be sized in accordance with Table 250.122, based on the ampere rating of the overcurrent device ahead of the feeder, but in no case is it required to be larger than the feeder tap conductors.

Figure 250-214

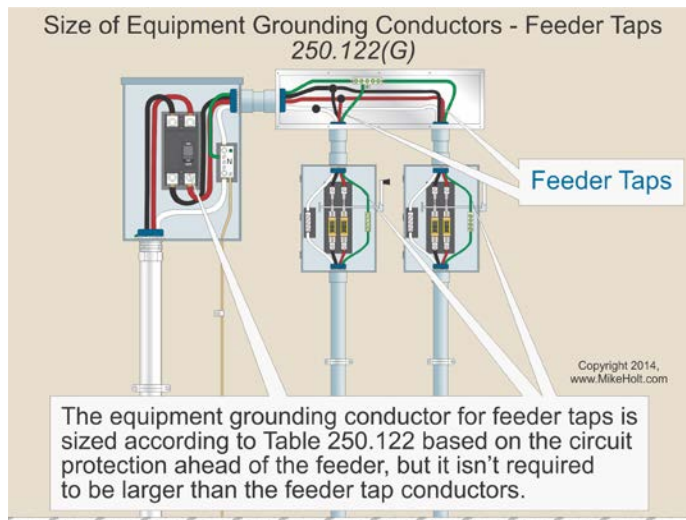

Figure 250-214

ARTICLE 404

SWITCHES

Introduction to Article 404—Switches

The requirements of Article 404 apply to switches of all types, including snap (toggle) switches, dimmer switches, fan switches, knife switches, circuit breakers used as switches, and automatic switches, such as time clocks and timers.

Rule #8: 404.2 Switch Connections



Scan this QR code for a video of this *Code* rule. See page xix for information on how to use the QR codes.

(A) Three-Way and Four-Way Switches. Wiring for 3-way and 4-way switching must be done so that only the ungrounded conductors are switched. [Figure 404-2](#)

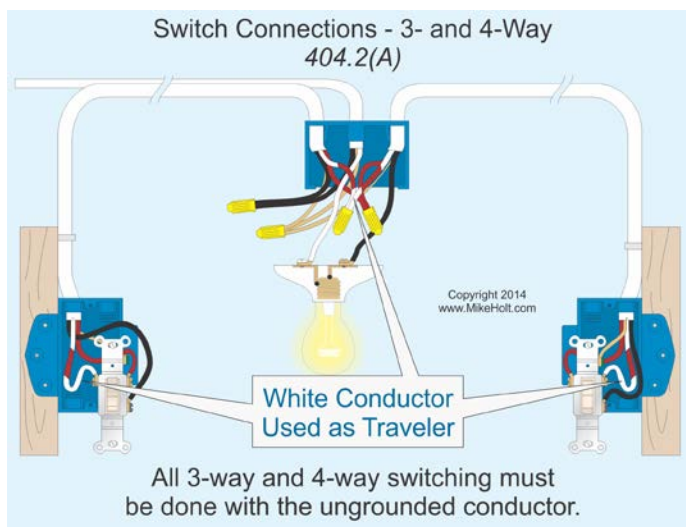

[Figure 404-2](#)

Author's Comment:

- In other words, the neutral conductor must not be switched. The white insulated conductor within a cable assembly can be used for single-pole, 3-way, or 4-way switch loops if it's permanently reidentified to indicate its use as an ungrounded conductor at each location where the conductor is visible and accessible [200.7(C)(2)].

If a metal raceway or metal-clad cable contains the ungrounded conductors for switches, the wiring must be arranged to avoid heating the surrounding metal by induction. This is accomplished by installing all circuit conductors in the same raceway in accordance with 300.3(B) and 300.20(A), or ensuring that they're all within the same cable.

Ex: A neutral conductor isn't required in the same raceway or cable with travelers and switch leg (switch loop) conductors. [Figure 404-3](#)

(B) Switching Neutral Conductors. Only the ungrounded conductor is permitted to be used for switching, and the grounded [neutral] conductor must not be disconnected by switches or circuit breakers. [Figure 404-4](#)

Ex: A switch or circuit breaker is permitted to disconnect a grounded circuit conductor where it disconnects all circuit conductors simultaneously.

(C) Switches Controlling Lighting Loads. Switches controlling line-to-neutral lighting loads must have a neutral provided at the switch location, other than in the following locations: [Figure 404-5](#)

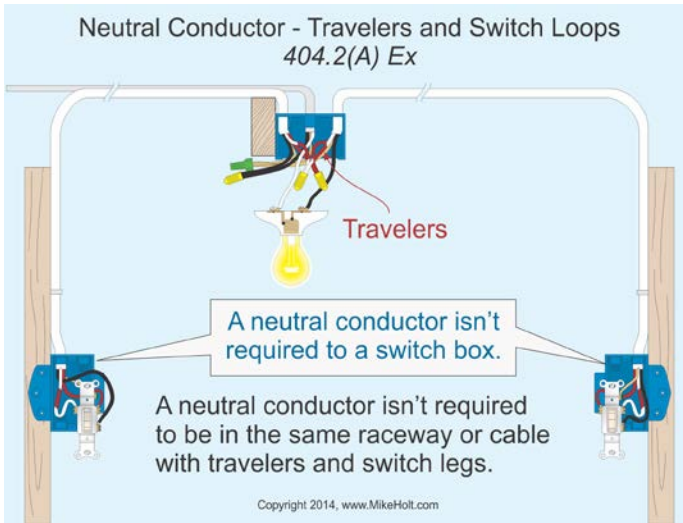

Figure 404-3

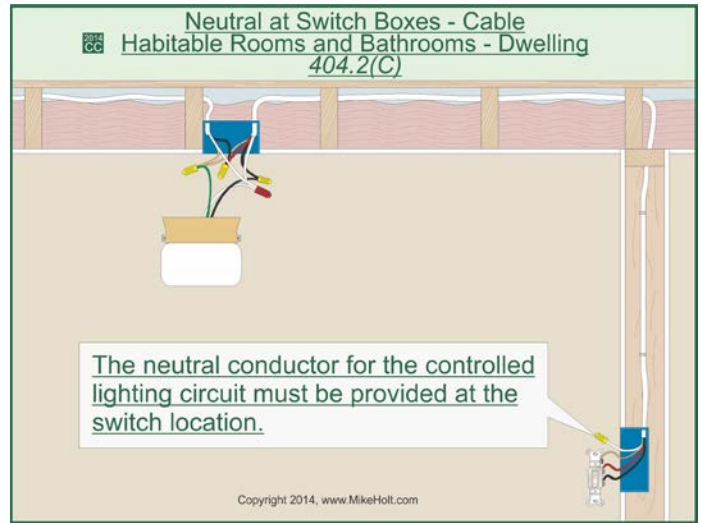

Figure 404-5

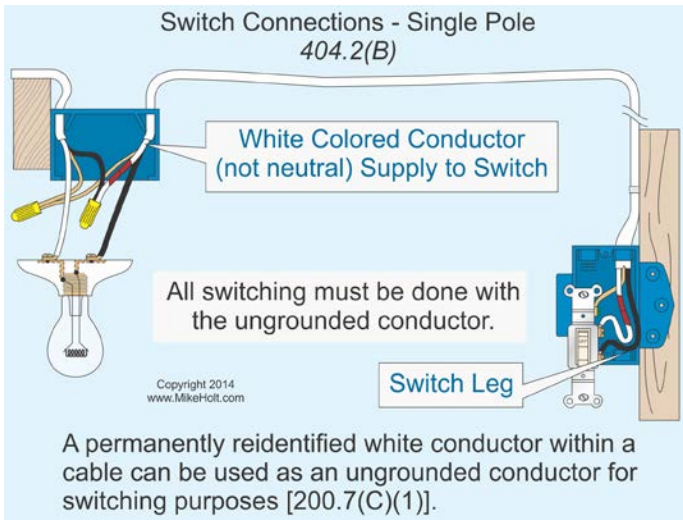

Figure 404-4

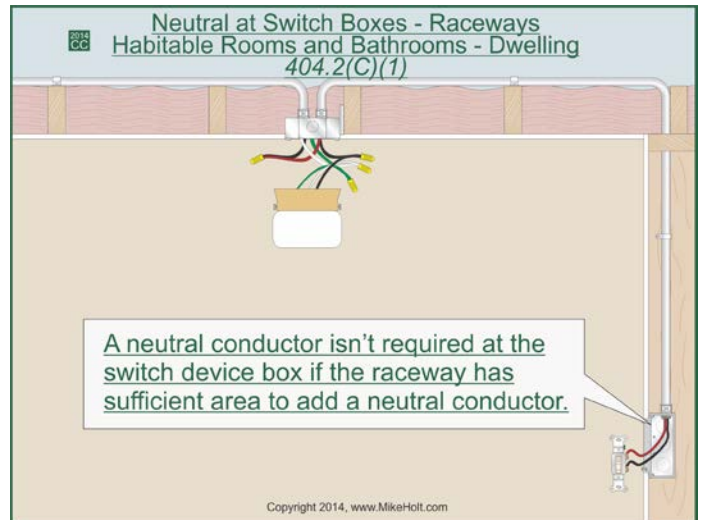

Figure 404-6

- (1) Where the conductors for switches enter the device box through a raceway that has sufficient cross-sectional area to accommodate a neutral conductor. Figure 404-6
- (2) Where the switch box can be accessed to add or replace a cable containing a neutral without damaging the finish of the building. Figure 404-7
- (3) Snap switches with integral enclosures [300.15(E)].
- (4) Nonhabitable rooms and bathrooms.

Author's Comment:

- A habitable space is a space in a building for living, sleeping, eating, or cooking. Bathrooms, toilet rooms, closets, halls, storage, or utility space and similar areas aren't considered habitable spaces. Therefore the current 2014 rule doesn't apply to commercial occupancies. Figure 404-8

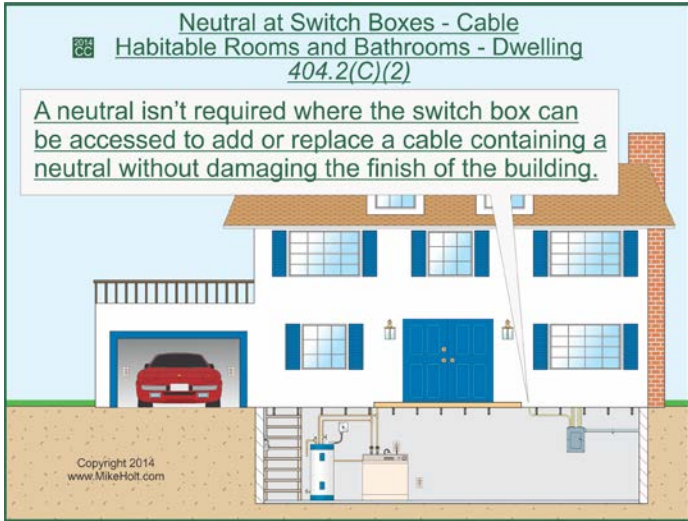

Figure 404-7

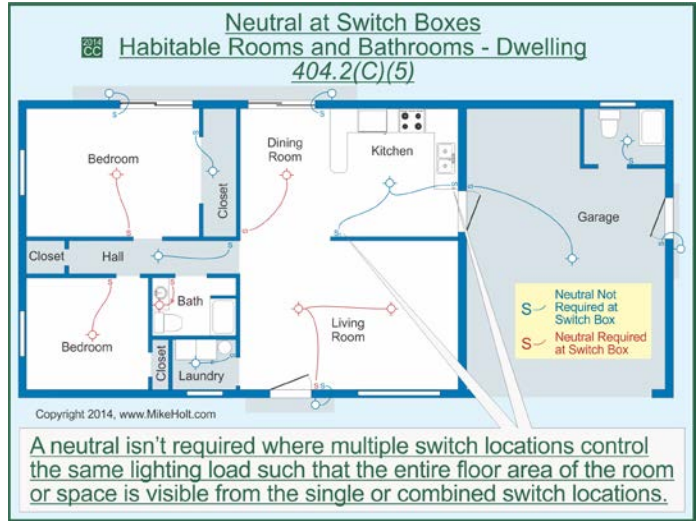

Figure 404-9

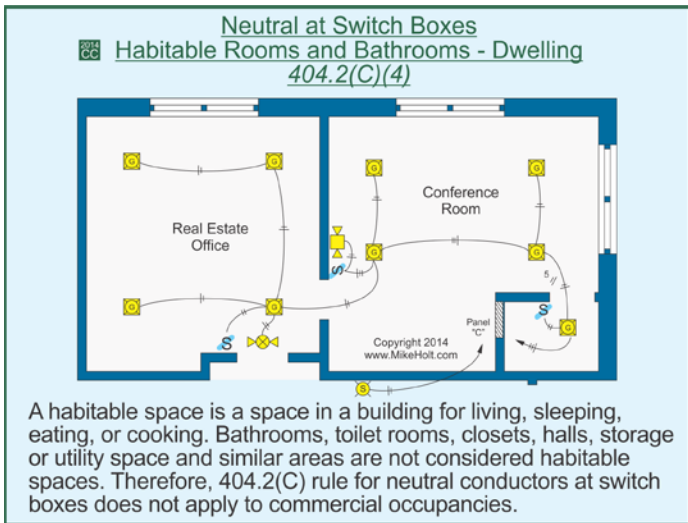

Figure 404-8

- (5) For 3-way and 4-way switches, but only if the entire floor area is visible from the switches' location(s). Figure 404-9

- (6) Where the lighting is controlled automatically.
- (7) Switches controlling receptacles. Figure 404-10

Note: The purpose of the neutral conductor is to complete a circuit path for electronic lighting control devices.

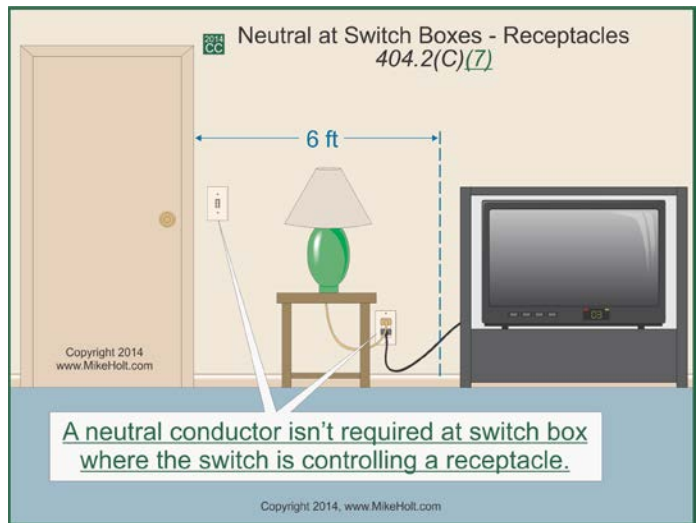

Figure 404-10

ARTICLE 406

RECEPTACLES, CORD CONNECTORS, AND ATTACHMENT PLUGS (CAPS)

Introduction to Article 406—Receptacles, Cord Connectors, and Attachment Plugs (Caps)

This article covers the rating, type, and installation of receptacles, cord connectors, and attachment plugs (cord caps). It also addresses their grounding requirements. Some key points to remember include:

- Following the grounding requirements of the specific type of device you're using.
- Providing GFCI protection where specified by 406.4(D)(3).
- Mounting receptacles according to the requirements of 406.5, which are highly detailed.

Rule #9:

406.12 Tamper-Resistant Receptacles

Tamper-resistant receptacles must be installed in the following areas:

Author's Comment:

- On a tamper-resistant receptacle, inserting an object into one side of the receptacle doesn't open the internal tamper-resistant shutter. Simultaneous pressure from a two or three pronged plug is required for insertion. [Figure 406-27](#)

(A) Dwelling Units. All nonlocking type 15A and 20A, 125V receptacles in the following areas of a dwelling unit [210.52] must be listed as tamper resistant. [Figure 406-28](#)

- Wall Space—210.52(A)
- Small-Appliance Circuit—210.52(B)
- Countertop Space—210.52(C)
- Bathroom Area—210.52(D)
- Outdoors—210.52(E)
- Laundry Area—210.52(F)
- Garage and Outbuildings—210.52(G)
- Hallways—210.52(H)



Figure 406-27

(B) Hotel and Motel Guest Rooms and Guest Suites. All Nonlocking type 15A and 20A, 125V receptacles in guest rooms and guest suites must be listed as tamper resistant.

(C) Child Care Facilities. Nonlocking type 15A and 20A, 125V receptacles in child care facilities must be listed as tamper resistant.

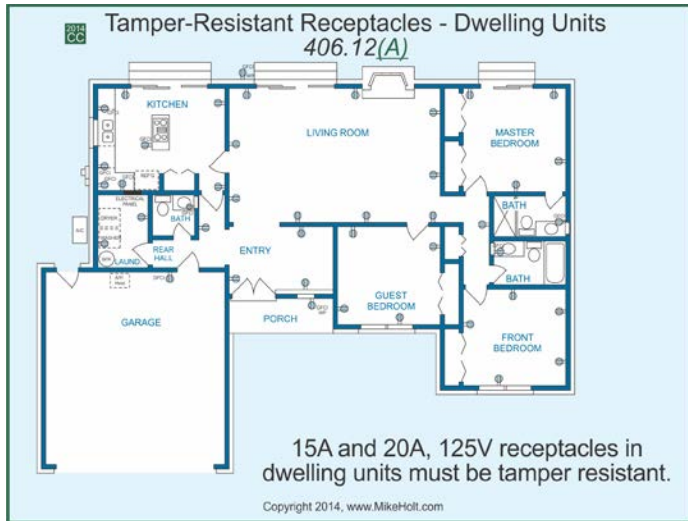

Figure 406–28

Author’s Comment:

- A child care facility is a building or portions thereof used for educational, supervision, or personal care services for five or more children seven years in age or less [406.2].

Ex: Receptacles in the following locations aren’t required to be tamper resistant:

- (1) Receptacles located more than 5½ ft above the floor.
Figure 406–29

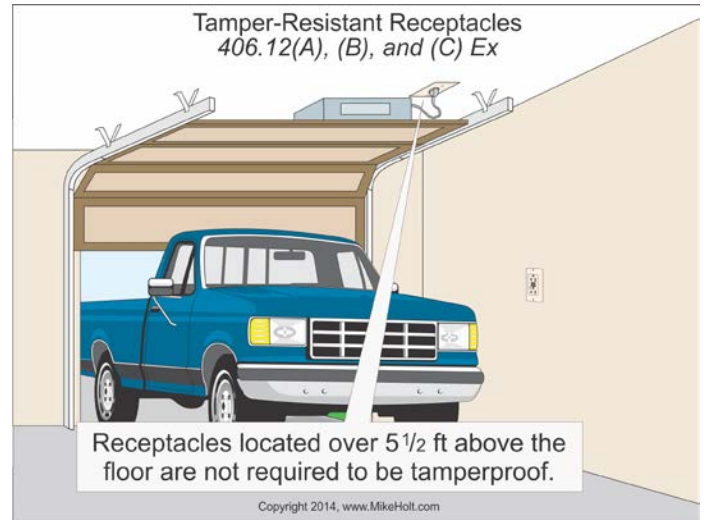

Figure 406–29

- (2) Receptacles that are part of a luminaire or appliance.
- (3) A receptacle located within dedicated space for an appliance that in normal use isn’t easily moved from one place to another.
- (4) Nongrounding receptacles used for replacements as permitted in 406.4(D)(2)(a).

ARTICLE 680

SWIMMING POOLS, SPAS, HOT TUBS, FOUNTAINS, AND SIMILAR INSTALLATIONS

Introduction to Article 680—Swimming Pools, Spas, Hot Tubs, Fountains, and Similar Installations

The requirements contained in Article 680 apply to the installation of electrical wiring and equipment for swimming pools, spas, hot tubs, fountains, and hydromassage bathtubs. The overriding concern of this article is to keep people and electricity separated.

Article 680 is divided into seven parts. The various parts apply to certain types of installations, so be careful to determine which parts of this article apply to what and where. For instance, Part I and Part II apply to spas and hot tubs installed outdoors, except as modified in Part IV. In contrast, hydromassage bathtubs are only covered by Part VII.

- **Part II—Permanently Installed Pools.** Installations at permanently installed pools must comply with both Parts I and II of this article.

Part II. Permanently Installed Pools, Outdoor Spas, and Outdoor Hot Tubs

Rule #10: 680.26 Equipotential Bonding

Author's Comment:

- The bonding requirements of this section don't apply to spas and hot tubs [680.42]

(A) Performance. The required equipotential bonding is intended to reduce voltage gradients in the area around a permanently installed pool. *Figure 680-39*



Scan the QR code for a video clip of Mike explaining this topic; this is a sample from the DVDs that accompany this textbook.



Figure 680-39

(B) Bonded Parts. The parts of a permanently installed pool listed in (B)(1) through (B)(7) must be bonded together with a solid copper

conductor not smaller than 8 AWG with listed pressure connectors, terminal bars, exothermic welding, or other listed means in accordance with 250.8(A). [Figure 680–40](#)

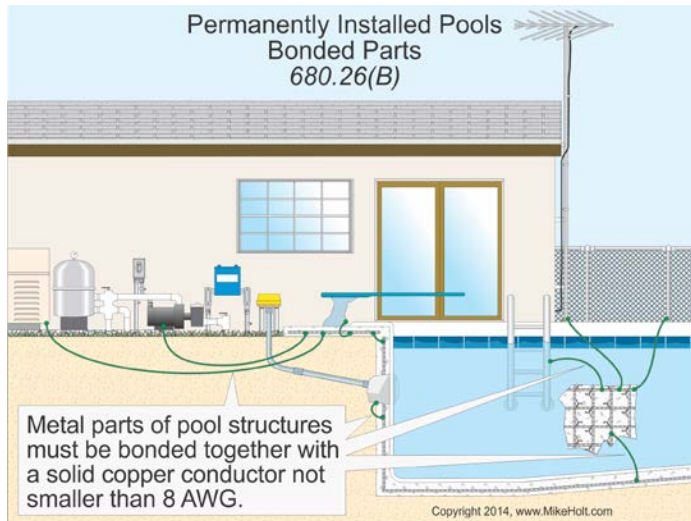

Figure 680–40

Equipotential bonding isn't required to extend to or be attached to any panelboard, service equipment, or grounding electrode.

(1) Concrete Pool Shells-Equipotential Bonding.

(a) Structural Reinforcing Steel. Unencapsulated structural reinforcing steel in concrete shells must be bonded together by steel tie wires.

[Figure 680–41](#)

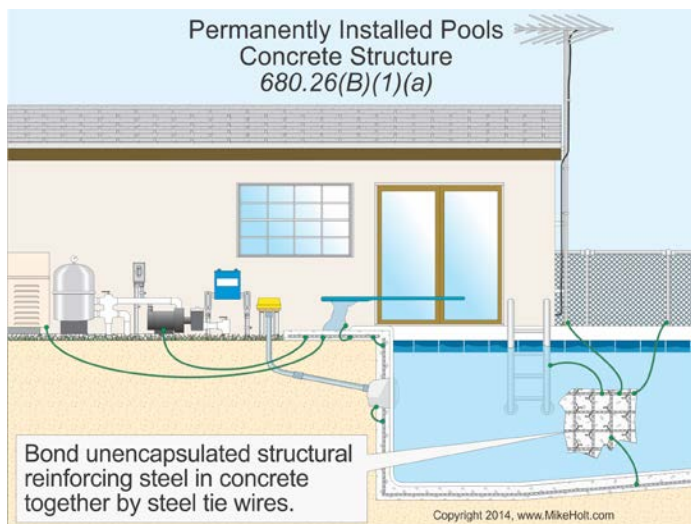

Figure 680–41

(2) Perimeter Surfaces. Equipotential bonding must extend 3 ft horizontally beyond the inside walls of a pool including unpaved, paved, and poured concrete surfaces. [Figure 680–42](#)



Figure 680–42

Author's Comment:

- The *NEC* doesn't provide any guidance on the installation requirements for structural reinforcing steel when used as a perimeter equipotential bonding method.

(b) Alternative Means. Where structural reinforcing steel isn't available (or is encapsulated in a nonconductive compound such as epoxy), equipotential bonding meeting all of the following requirements must be installed: [Figure 680–43](#)

- (1) The bonding conductor must be 8 AWG bare solid copper.
- (2) The bonding conductor must follow the contour of the perimeter surface.
- (3) Listed splicing devices must be used.
- (4) The required conductor must be located between 18 in. and 24 in. from the inside walls of the pool.
- (5) The bonding conductor must be secured in or under the deck or unpaved surface within 4 in. to 6 in. below the subgrade.

(3) Metallic Components. Metallic parts of the pool structure must be bonded to the equipotential grid.

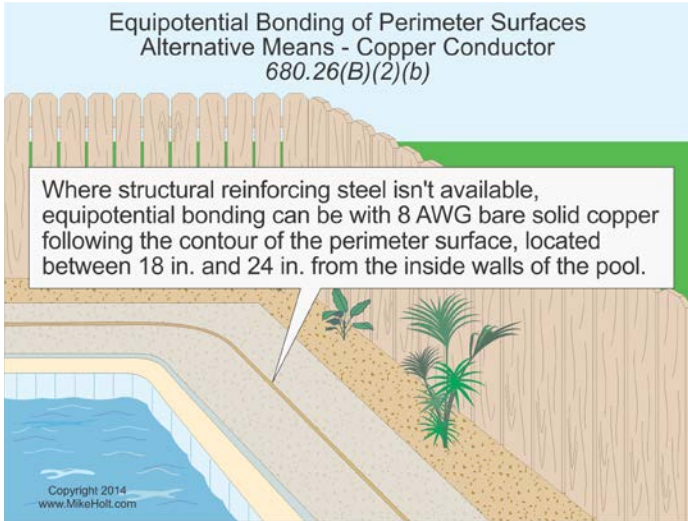

Figure 680-43

(4) Underwater Metal Forming Shells. Metal forming shells and mounting brackets for no-niche luminaires and speakers must be bonded to the equipotential grid.

(5) Metal Fittings. Metal fittings 4 in. and larger located within or attached to the pool structure, such as ladders and handrails must be bonded to the equipotential grid. [Figure 680-44](#)

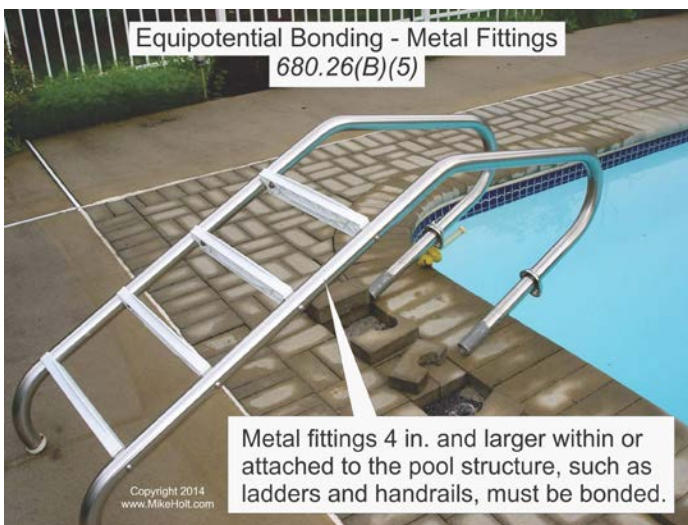

Figure 680-44

(6) Electrical Equipment. Metal parts of electrical equipment associated with the pool water circulating system, such as water heaters, pump motors, and metal parts of pool covers must be bonded to the equipotential grid. [Figure 680-45](#)

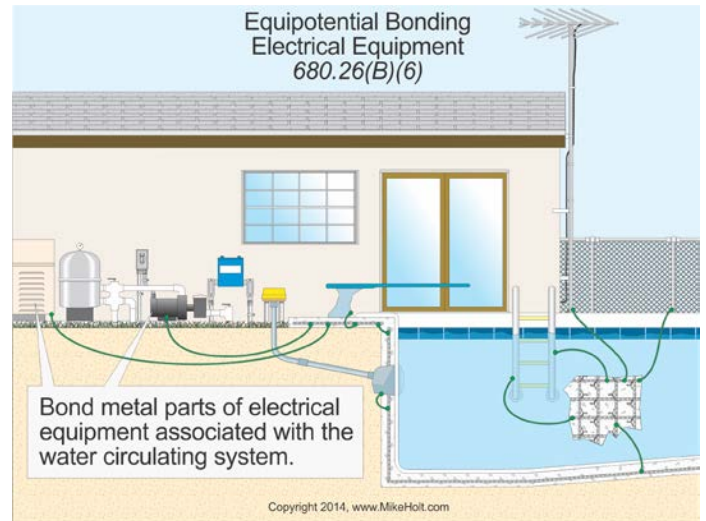

Figure 680-45

Ex: Metal parts of listed double-insulated equipment aren't required to be bonded.

(a) Double-Insulated Water-Pump Motors. If a double-insulated water-pump motor is installed, a solid 8 AWG copper bonding conductor must be provided for a replacement motor.

(7) Fixed Metal Parts. All fixed metal parts must be bonded to the equipotential grid, including but not limited to, metal-sheathed cables and raceways, metal piping, metal awnings, metal fences, and metal door and window frames. [Figure 680-46](#)

Ex 1: If separated from the pool structure by a permanent barrier that prevents contact by a person.

Ex 2: If located more than 5 ft horizontally from the inside walls of the pool structure. [Figure 680-47](#)

Ex 3: If located more than 12 ft measured vertically above the maximum water level.

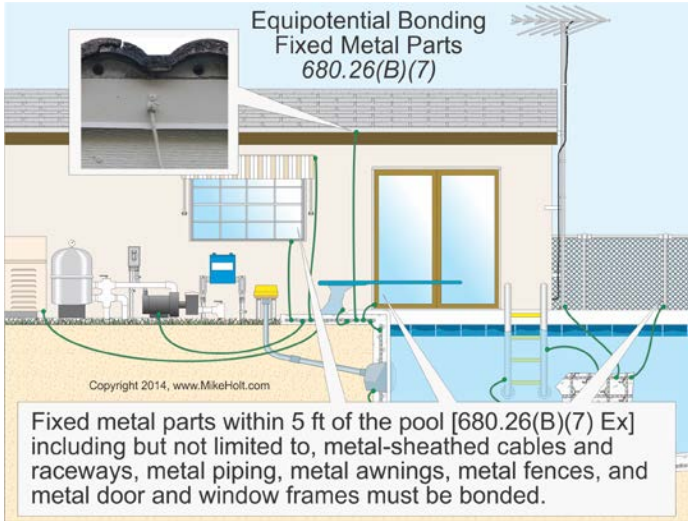

Figure 680-46

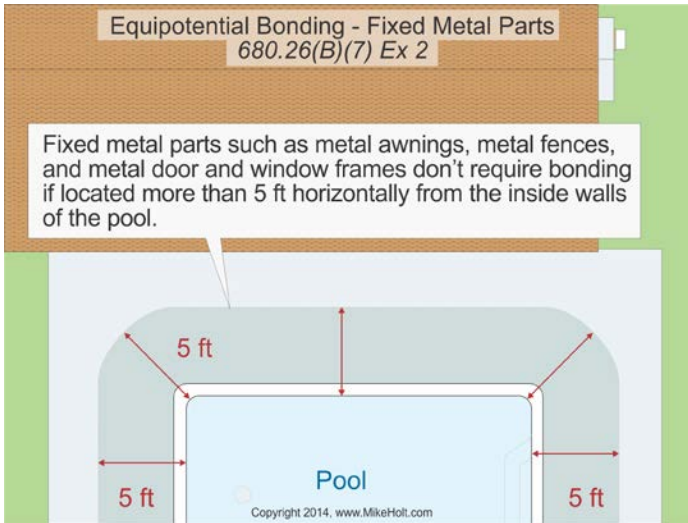

Figure 680-47

(C) Pool Water. If the pool water doesn't have an electrical connection to one of the bonded parts described in 680.26(B), an approved corrosion-resistant conductive surface that's at least 9 sq in. must be in contact with the water. The corrosion-resistance conductive surface must be bonded in accordance with 680.26(B), and be located in an area where it won't be dislodged or damaged or dislodged during normal pool usage. Figure 680-48

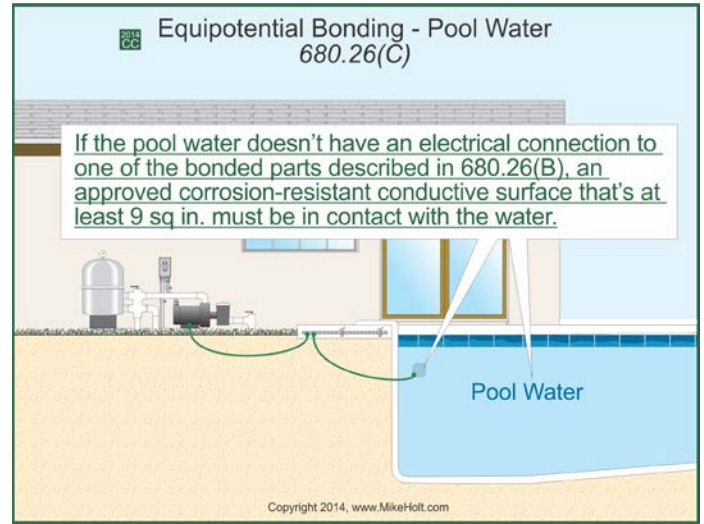
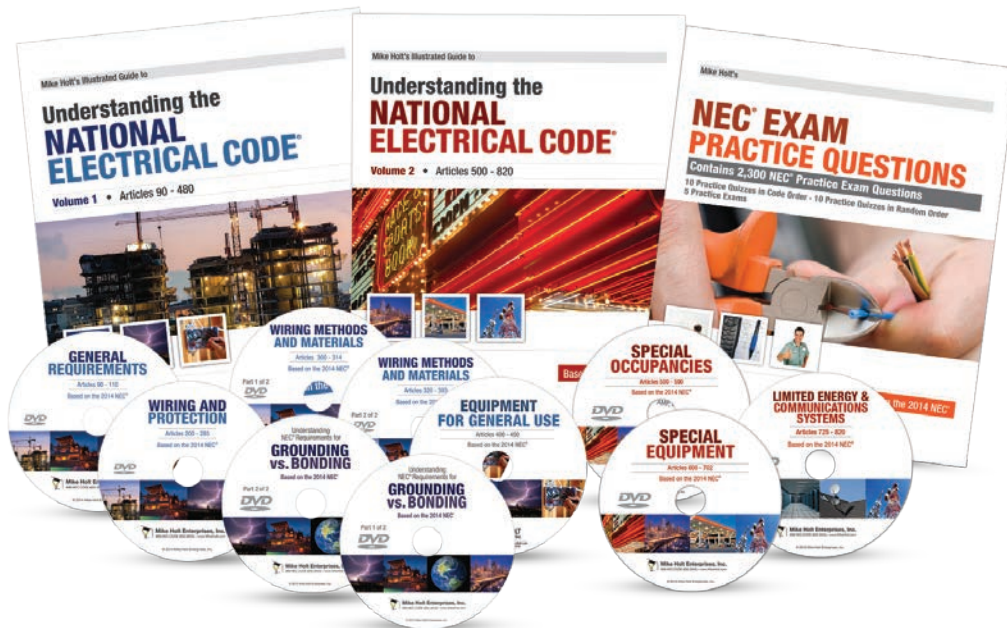

Figure 680-48

20% OFF

Mike Holt's DETAILED CODE LIBRARY



| PERFECT FOR ENGINEERS, ELECTRICIANS, CONTRACTORS AND ELECTRICAL INSPECTORS |

There isn't a better way to learn the Code than with Mike's Detailed Code Library. It takes you step-by-step through the NEC® in Code order, combining the unique writing style of Mike's textbooks, with his dynamic teaching style on the training DVDs. You get detailed instructional graphics, great practice questions, and in-depth analysis by Mike and a team of industry experts explaining the rules and their practical application.

Get your Copy for 20% off list price – use discount code UNDPDF14

“...as for me and my house, we will serve the Lord.” [Joshua 24:15]

NAME _____		TITLE _____	
COMPANY _____			
ADDRESS _____			
CITY _____	STATE _____	ZIP _____	
PHONE _____			
E-MAIL ADDRESS _____			
<input type="checkbox"/> VISA	<input type="checkbox"/> MASTERCARD	<input type="checkbox"/> DISCOVER	<input type="checkbox"/> AMEX
<input type="checkbox"/> MONEY ORDER	<input type="checkbox"/> CHECK		
CREDIT CARD # _____		EXP. DATE _____	
3 OR 4 DIGIT SECURITY CODE ON FRONT OF AMEX OR BACK FOR ALL OTHERS _____			

2014 DETAILED CODE LIBRARY ORDER FORM			
	PRICE	QTY	TOTAL
<input type="checkbox"/> DVD Program (includes 3 books & 10 DVDs)	List Price \$599 \$479.20	_____	\$ _____
		SUB-TOTAL	\$ _____
	SALES TAX (FLORIDA RESIDENTS ONLY) ADD 6%		\$ _____
	Shipping (5% of total price) - Minimum \$7.50		\$ _____
		TOTAL	\$ _____
Mail form to: 3604 Parkway Blvd., Suite 3, Leesburg, Florida 34748			
FOR VOLUME DISCOUNTS PLEASE CALL OUR OFFICE			

Visit: www.MikeHolt.com/14DECO • **Call:** 888.NEC.CODE (632.2633) • **Fax:** 352.360.0983

Offer good through December 31, 2015



MIKE HOLT Enterprises, Inc.